

تقدير تردد الاهتزازات لأسطح الأرضيات الإنشائية باستخدام تقنيات الذكاء الاصطناعي ومحاكاة العناصر المحددة

*عباس سيفاندي بور، *إحسان نوروزينجاد فارساني و*إيزورو تاكيواكي
*كلية الهندسة المدنية والمساحة، جامعة الدراسات العليا للتكنولوجيا المتقدمة، كرمان، إيران
**قسم العمارة والهندسة المعمارية، جامعة كيوتو، كيوتو، اليابان

الخلاصة

الأنشطة البشرية (مثل: المشي والجري وما إلى ذلك) وتشغيل الآلات بشكل عام تؤدي إلى اهتزاز أسطح الأرضيات وبالتالي تسبب إزعاجاً للسكان. ويتم تحديد تردد الاهتزازات الطبيعي للعوارض كمصدر رئيسي وكذلك معلمة التحكم في هذه الظاهرة. وفي السنوات الأخيرة، قد أجريت العديد من الدراسات لتحديد التردد الطبيعي للعوارض؛ ومع ذلك، تُعتبر الصيغ المقترحة في العديد منها غير عملية للتحكم في الاهتزازات في طوابق المباني العالية. في هذا البحث، تم اعتماد التحليل بطريقة العناصر المحددة (FEM) والتحليلات الديناميكية غير الخطية (NL) وتقنيات الذكاء الاصطناعي (AI) لتشكيل معادلات التردد البسيطة للنهائيات الثابتة والعوارض من الصلب الكابولي للتحكم في اهتزاز الأرضيات. تتم محاكاة بيانات الإدخال المطلوبة لتدريب النموذج القائم على تقنيات الذكاء الاصطناعي في منصة التحليلات الديناميكية غير الخطية وطريقة العناصر المحددة (NL FE) مع مراعاة الحالات المختلفة لوصلات العزم الفولاذية. أشارت نتائج التحليل لعدة مئات من العوارض ذات الخصائص المختلفة إلى أن قيم تردد الاهتزازات المحسوبة للنهائيات الثابتة وللعوارض الكابولية كانت أكبر من قيمة تردد العوارض المدعومة ببساطة في ظروف مماثلة بـ 2.07 و 0.33 مرة على التوالي. لهذا، تم تحديد تقنية الحوسبة الناعمة التي تم تنفيذها كنهج فعال لتحسين الكفاءة الحسابية لمحاكاة NL-FE.

Estimation of Vibration Frequency of Structural Floors Using Combined Artificial Intelligence and Finite Element Simulation

Abbas Sivandi-Pour*, Ehsan Noroozinejad Farsangi* and Izuru Takewaki**

* Faculty of Civil and Surveying Engineering, Graduate University of Advanced Technology, Kerman, Iran.

** Department of Architecture and Architectural Engineering, Kyoto University, Kyoto, Japan.

Corresponding Author: noroozinejad@kgut.ac.ir

Submitted: 21/04/2019

Revised: 05/12/2019

Accepted: 08/03/2020

ABSTRACT

Floor vibration due to human activities (walking, running, etc.) and operating machines generally makes inconveniences for residents. The natural vibration frequency of beams is determined as the main source and also the controlling parameter of such the phenomenon. Many studies have been conducted on determining the natural frequency of beams in recent years; however, the proposed formulations in many of them are not very practical for vibration control of tall building floors. In this paper, the finite element method (FEM), nonlinear (NL) dynamic analyses, and artificial intelligence (AI) techniques were adopted to constitute the simple frequency equations of the fixed ends and cantilever steel beams for controlling the floor vibration. The input data required for training the AI-based model are simulated in a NL FE platform considering various cases of the steel moment connections. The analysis outcome of several hundred beams with different properties indicated that the calculated vibration frequency values of the fixed ends and cantilever beams were respectively 2.07 and 0.33 times larger than the frequency value of the simply supported beams with similar conditions. To this, the implemented soft computing technique was determined as an effective approach to improve the computational efficiency of the NL-FE simulations.

Keywords: Floor vibration; Artificial intelligence; Finite element method; Dynamic analysis; Natural frequency; Steel buildings; Moment connection.

INTRODUCTION

Vibration control of floors in framed steel structures is of great importance and it very much depends on the beam's vibration. For two reasons, the vibration of steel beams under the moving loads should be investigated. On one hand, the stresses under the dynamic (live) loads may reach higher than those under the static (dead) loads. On the other hand, further vibration makes an unpleasant feeling for the occupants and may cause structural and non-structural damages, which is usually unwarranted due to linear deformation and stresses. Nevertheless, the induced floor vibration may cause undesirable feeling for the occupants and disrupts their tasks to be carried out efficiently (Wang et al., 2015, Bigdeli and Kim, 2017, Middleton and Brownjohn, 2010, Nguyen et al., 2001, Yoon et al., 2006, Živanović et al., 2005).

The traditional approach to design floors and beams was based on ultimate limit state (ULS); however, the recent approach is toward serviceability limit state (SLS), which prevents collapse or structural damages as well as limiting

the cracks in finishes. The design codes stipulate that both ULS and SLS requirements should be fulfilled. However, as we push the envelope of certain structural members, SLS requirements may become governing in the design. (Yoon et al., 2006, Živanović et al., 2005, Abdel-Jaber et al., 2008, Soedel, 1982). Vibration in tall and super-tall buildings has become a major concern for both researchers and engineering communities in the past decades. The reason is mainly due to the sensitivity of some scientific, manufacturing and medical equipment to vibration (Middleton and Brownjohn, 2010, Živanović et al., 2005, Soedel, 1982). The dynamic characteristic of floor beams is considered as the key component for calculating and controlling the floor vibrations. Different design guidelines and code provisions provide generalized equations for computing the vibration frequency of floor systems. However, due to generalization, natural vibration frequency predictions may sometimes vary considerably from the actual frequency.

Many studies have been conducted on the natural vibration frequency of beams. Yoon et al. (2006) studied the natural vibration frequencies of thin-walled curved beams and derived analytical equations for these types of elements. Abdel-Jaber et al. (2008) studied the natural frequency of elastically restrained tapered beam with a reduced section using harmonic balance and time transmission methods and presented a relationship for the natural vibration frequency.

Heins and Sahin (1979) have modified the 1st mode vibration frequency formulation for simply supported beams using finite difference method. Parametric study for multi-span continuous beams using lamed mass method to investigate the natural vibration frequency of these elements has been done by (Billing, 1979). Duan (2008) investigated the free vibration of asymmetric thin-walled circularly curved beams with an open cross-section using the finite element analysis and introduced a new formulation. Sanchez and Murray (2010) have investigated the vibration characteristics of long-span floors. Both response accelerations and natural frequencies of the investigated systems were calculated using FE analyses. Numerical results have been verified through experimental studies and some recommendations were provided by the authors.

Design provisions from the (AISC, 2005 and 2017) and Canadian Standards Association (CSA, 1989) provide equations for predicting and controlling the natural vibration frequency of steel beams. These codes emphasize that the connected beams to large areas without beam partitions (or any other elements that have the property of vibration dampness) should be controlled based on shaking and vibration of kinetic loads (walking, elevator movement, etc.).

A simple and practical analytical formulation of the free vibration of moment connection for the steel beams is not yet available in the literature. The presented relations in the existing studies are becoming complicated for computing and controlling the floor vibration of tall building floors. In the current study, simple yet accurate vibration frequency equations for the fixed ends and the cantilever steel beams are presented for computing the vibration of the floor. In literature, different methods, such as the dynamic analysis (Leissa, 2005), the superposition method (Gorman, 1990) and the finite element method (FEM) (Ahmed, 1971), were used for determining the natural frequencies of beams. In the current study, the combined nonlinear dynamic analysis, FEM and artificial neural networks (ANN) have been adopted to constitute the vibration frequency equations of the fixed ends and cantilever steel beams. ANN is determined as one of the most recent approaches to complicated problem solving, which its capability in solving engineering problems has been proved. The application of ANN-based techniques covers a wide variety of topic e.g. pattern recognition, function approximation and etc. (Keskin Riza, 2017, Naderpour, H., et al., 2019).

In this study, two hundred beams with different cross-sections commonly used as steel floor beams in practice were designed for the simulation procedure. The selection of data for the ANN and FEM covered various cases. The natural vibration frequency of beams was then obtained using combined FE and ANN methods and finally simplified yet reliable equations for the natural frequency computation of fixed ends and cantilever beams using nonlinear regression analysis were proposed.

DYNAMIC RELATIONSHIPS FOR BEAM VIBRATION

In order to calculate the natural vibration frequency of steel beams according to the condition of both ends fixities, the first significant step is to consider dimensional and physical characteristics of the beams (bending stiffness variation and mass over the length unit) (Billing, 1979, Przybylski, 2009, Yamada and Veletsos, 1958).

One of the main issues in previously conducted studies has been the considerable numerical calculations to predict the natural vibration frequency of structures, which makes them computationally inefficient. Yamada and Veletsos (1958) proposed a numerical solution for obtaining the natural vibration frequency of short bridges using both dynamic analysis procedure and orthotropic plate theory. A demanding numerical technique was proposed by Veletsos and Newmark (1957) to determine the natural frequency of straight continuous beams. Figure 1 shows the free diagram of a fixed ends beam.

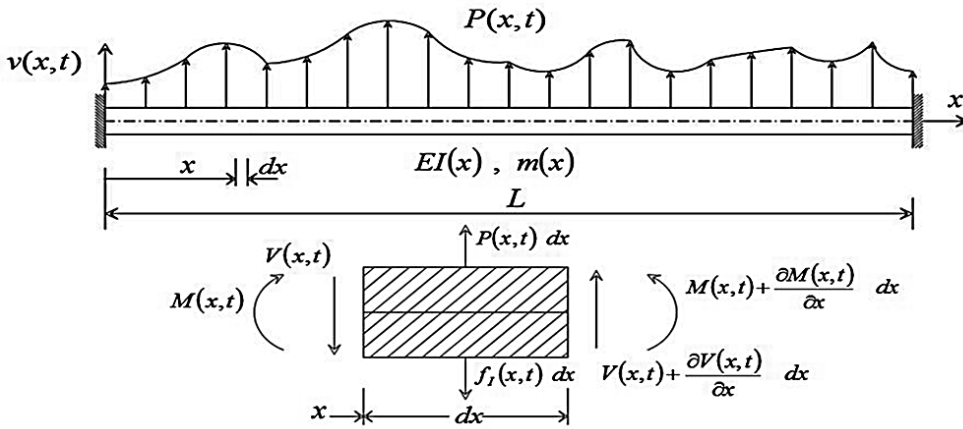

Figure 1. Fixed supported beam under loading

The widely recognized general equation of beam vibration is shown in Eq. 1. Ignoring the effect of axial forces and assuming that the moment of inertia is constant along the beam length, Eq. 1 changes to Eq. 2.

$$\frac{\partial^2}{\partial x^2} \left[EI(x) \frac{\partial^2 v(x,t)}{\partial x^2} \right] - \frac{\partial}{\partial x} \left[N(x) \frac{\partial v(x,t)}{\partial t} \right] + m(x) \frac{\partial^2 v(x,t)}{\partial t^2} = p(x,t) \tag{1}$$

$$\left[EI \frac{\partial^4 v(x,t)}{\partial x^4} \right] + \left[m(x) \frac{\partial^2 v(x,t)}{\partial t^2} \right] = p(x,t) \tag{2}$$

Where E is the modulus of elasticity, I is the moment of inertia, $v(x,t)$ is the beam deflection at location x and time t , $N(x)$ is the axial force in beam at location x , $m(x)$ is the mass function at location x , and $p(x,t)$ is the applied transverse loading over beam length at location x and time t . In a free vibration condition, by assuming constant mass and bending stiffness along the beam and using the variable separation method for solving minor derivatives equations, Eq. 2 can be solved and, the main equation is achieved as Eq. 3.

$$\frac{\phi^{iv}(x)}{\phi(x)} + \frac{m}{EI} \frac{\ddot{Y}(t)}{Y(t)} = 0 \tag{3}$$

Where $Y(t)$ is the vibrating swing time and $\phi(x)$ is a function of displacement in length. Since, in building frame structures, beams are typically under uniform loading condition, hence the applied loads have been considered to be uniform. By applying the boundary conditions to Eq. 3, the first mode natural vibration frequency for any beams with constant joint conditions and simple uniform loading could be expressed as Eq. 4.

$$f_1 = \beta \sqrt{\frac{I}{PL^4}} \quad (4)$$

Where I is the moment of inertia, P is the uniform dead load, L is the beam length, f_1 is the natural vibration frequency and β is the constant coefficient which depends on the boundary conditions. If the modulus of elasticity of the member (E) is constant, the effect of this value needs to be only considered in β coefficient.

CONTROLLING FLOORS VIBRATION VS. NATURAL VIBRATION FREQUENCY OF BEAMS

The floor vibration has a threshold mainly based on what occupants would experience during such disturbances. In conventional structural design approaches, the floor should be designed in a way to have natural vibration frequency greater than the critical forcing frequency to avoid resonance phenomenon.

E.g. the acceleration of around 0.5g is considered undesirable for people in the offices or residences, whereas for those people beside a dance floor or standing in a shopping center much higher vibrations are tolerable (Naeim, 1991, Allen and Pernica, 1998). The AISC (2005) and CSA (1989) have introduced an equation for determining the natural frequency of beams based on the deflection. The formulation is given in Eq. 5.

$$f = 0.18 \sqrt{\frac{g}{\Delta}} \quad (5)$$

Where Δ is the beam mid-span deflection relative to its supports and g is the ground acceleration.

APPLYING ARTIFICIAL INTELLIGENCE TO DETERMINE NATURAL VIBRATION FREQUENCY

Artificial intelligence-based approaches have the capability of solving or formulating complex engineering problems. The development of artificial neural networks (ANNs) as one of the most well-known artificial intelligence techniques was inspired by the characteristics and capabilities of the human brain structure in which learning and training basically depend on experiments. Thus, an ANN, in general, consists of interconnected computing units that are geometrically organized in one, two or three dimensions, and the individual processing parts are called ‘neurons’ (Bigdeli and Kim, 2017).

Each ANN has an architecture including several layers; an input layer, an output layer and a number of hidden layers. Layers between the internal and external layers are called hidden layers. These layers are responsible for analyzing and processing the input data and sending them to the external layer; the external layer then converts the obtained data into an external vector for the neural network. Propagation takes place in a feed-forward manner from the input to the output layers. The connectivity pattern and number of nodes in each layer may vary with some constraints. One of the main constraints is that there should be no communication between the processing units within a layer; however, the outputs of each processing unit may be sent to higher layers.

The multi-layer feed forward (MLFF) neural networks with the back-propagation (BP) training algorithms are one of the most commonly used ANN architectures and were implemented herein. Levenberg-Marquart function (Moré,

1978) was used as the training function and the Log-Sigmoid function (Nandi and Azzouz, 1998) was used as the provoking function. The computational efficiency of the Feed-forward ANNs is due to the fact that the interconnections have no closed paths or loops. It is a form of supervised training. The formulation is given in Eq. (6).

$$y = f(Uf(Wx)) \tag{6}$$

where,

$x = [1, x_1, x_2, \dots, x_p]^T$ is the input vector with size p and one bias input with size $((p + 1) \times 1)$.

$W = ((M + 1) \times (p + 1))$ is the matrix of weights w_{ij} between hidden input nodes.

$U = (K \times (M + 1))$ is the matrix of weights u_{ij} between hidden output nodes.

y is the output vector of size $(M+1)$.

p is the number of real input nodes.

K is the number of output nodes.

More detailed forms of Eq. (6) are presented in Eqns. (7) – (9).

$$h_j = f_i(\sum_{i=0}^p W_{ji} \cdot x_i), \text{ for } j = 1, 2, \dots M \tag{7}$$

$$y_k = f_k(\sum_{i=0}^p u_{kj} \cdot h_j), \text{ for } k = 1, 2, \dots k \tag{8}$$

$F(z)$ is the activation function, defined in Eq. (9). The activation function is applied to the hidden and output neurons and introduces the nonlinearity into the ANN.

$$f(z) = f_j(z) = f_k(z) = \frac{1}{1+e^{-z}} \tag{9}$$

Figure 2 indicates the concept and use of ANN structure for the beam analysis in this paper. In this study, the internal data have been I (moment of inertia), L (span length), P (applied load), and the only output is the f (natural vibration frequency). Different neural networks were trained for internal data and the best architecture was determined as a network with 7 neurons in 1 hidden layer.

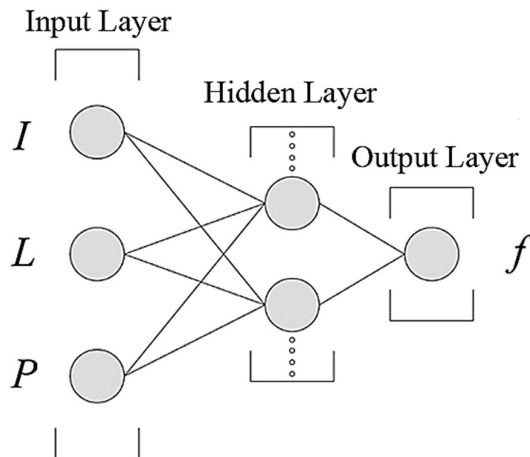

Figure 2. The structure of the three-layer ANN computing natural frequency

Each layer consists of some specific neurons connected to the neurons in other layers by weight coefficients. These coefficients were corrected during the process of network training according to the returning algorithm. The input data to the neuron (i) was the summation of multiplying the externally connected neurons to the neuron (i) in the quantities of their connected weights (Eq. 10).

$$x_i = w_{i0} + \sum_{j=1}^N w_{ij} x_j \quad (10)$$

Here, x_i is the internal data to the neuron (i), N is the total number of neurons related to the neuron (i) and w_{i0} is the bias weight of neurons. The external results from neurons are given in Eq. 11.

$$V_i = g(x_i) \quad (11)$$

Where V_i is the neuron external data and g is the provoking function.

The purpose of training the neural network is to find the optimum weights of the problem and to minimize the mean square error (MSE). Upon updating the weights, the ANN starts producing new external data and then calculates the MSEs. After completion of network training and modification of its weights, the network starts to be verified using internal data. If the network responds correctly to the data that have been involved through the process (test data), then the network has been accurately trained and could be used for further computation of different input data.

USING FINITE ELEMENT METHOD FOR TRAINING ANN

In order to obtain the required data for training ANN to control and compute the vibration frequency values for both cantilever and fixed ends beams, the general-purpose finite element software, ANSYS (2016), has been used for the analyses. Hundreds of fix ends and cantilever beams were designed conforming AISC-LRFD (2017) code of practice. In the design process, a wide range of span length and load values that are commonly used in the design of steel frame structures have been used to reflect the natural vibration frequency of common floor beams used in practice. BEAM189 element type has been used for numerical simulation. The element is a quadratic element with 6 DOF at each node. This element can be used for both linear and nonlinear applications. The used element can simulate large stration/rotation and shear deformation effects.

Applied load ranges from 5 to 25 kN/m, in increments of 5 kN/m (i.e. 5, 10, 15, 20 and 25 kN/m). The properties of the beams are shown in Tables 1 and 2 for fixed ends and cantilever beams, respectively. The frequencies of all the beams were calculated using FEM, and then verified through design equations and available analytical relations. Then, results from 90% of beams population were used for training the ANN.

In order to determine the ideal model, NN 3-7-1 was chosen since it provides acceptable results in the case of R-values and also has the least value of MSE among all networks. The results for choosing the number of hidden layers and the number of neurons in the hidden layer are shown in Tables 3 and 4, respectively.

Table 1. Properties and natural frequencies of fixed ends beams

No	L (m)	I (Cm ⁴)	Load (kN/m)	Frequency (Hz)	No	L (m)	I (Cm ⁴)	Load (kN/m)	Frequency (Hz)
1	6.2	869	5	4.71	51	6.3	3890	15	6.13
2	5.5	869	5	6.23	52	3.6	869	15	8.31
3	4.8	541	5	6.82	53	3.3	869	15	10.52
4	3.7	318	5	8.69	54	4.4	1940	15	7.96
5	4.4	318	5	6.18	55	2.8	541	15	10.71
6	5.4	869	5	6.95	56	3.1	541	15	8.82
7	6.3	869	5	4.54	57	3.9	1940	20	9.25
8	3.2	171	5	9	58	4	1940	20	9.19
9	5.7	869	5	5.81	59	6	5790	20	6.81
10	6.6	1320	5	5.66	60	6.8	8360	20	6.2
11	2.5	80.1	5	9.75	61	5	3890	20	8.25
12	4.3	318	5	6.32	62	2.6	541	20	11.27
13	4.9	541	5	6.7	63	6.7	8360	20	6.68
14	4.5	541	5	7.88	64	6.6	8360	20	6.56
15	7	1320	5	5.05	65	4.2	1940	20	8.31
16	3	171	5	10.04	66	4.1	1940	20	8.43
17	4.6	541	5	6.8	67	2.5	541	20	12.07
18	3.4	171	5	7.7	68	4.8	2770	20	7.56
19	5	541	5	6.28	69	5.2	3890	20	7.25
20	4	318	5	7.59	70	4.3	2770	20	8.68
21	6.8	2770	10	4.94	71	3.5	1320	20	9.45
22	4.3	869	10	7.02	72	2.7	869	20	12.74
23	3.2	541	10	10.26	73	2.8	869	20	11.16
24	5.4	1940	10	6.59	74	5.9	5790	20	6.72
25	5.3	1940	10	6.94	75	5.7	5790	20	7.5
26	6.2	2770	10	5.94	76	4.5	2770	20	8.33
27	6	1940	10	5.97	77	4.4	3890	25	9.01
28	2.6	318	10	11.98	78	3	1320	25	12.59
29	4.9	1320	10	7.54	79	4.8	3890	25	7.62
30	6.1	2770	10	6.87	80	4.2	2770	25	8.36
31	5.8	1940	10	6.26	81	4.3	2770	25	8.83
32	2.7	318	10	10.79	82	3.4	1940	25	11.27
33	5.1	1320	10	6.18	83	5.2	5790	25	8.16
34	6.6	2770	10	5.79	84	6.3	8360	25	6.23
35	4	869	10	8.52	85	5.3	5790	25	7.82
36	4.1	869	10	8.63	86	6.4	8360	25	6.33
37	3.7	541	10	7.25	87	2.8	869	25	10.94
38	3.4	541	10	9.5	88	6.1	8360	25	7.05
39	3.6	541	10	8.36	89	4.9	3890	25	8.11
40	4.8	1320	10	7.61	90	4	2770	25	10.3
41	6.8	5790	15	6.33	91	2.7	869	25	10.82
42	4.1	1320	15	8.03	92	6.6	11770	25	7.41
43	5.9	3890	15	6.7	93	5.7	5790	25	6.5
44	4.6	1940	15	7.67	94	7	11770	25	6.1
45	7	5790	15	5.52	95	3.7	1940	25	8.6
46	2.5	318	15	10.15	96	5.5	5790	25	6.84
47	5.8	3890	15	6.89	97	6	8360	25	7.4
48	4.9	1940	15	7.04	98	3.6	1940	25	9.82
49	4.5	1940	15	8.46	99	5	5790	25	8.47
50	3	541	15	9.51	100	4.1	2770	25	8.64

Table 2. Properties and natural frequencies of cantilever beams

No	L (m)	I (Cm ⁴)	Load (kN/m)	Frequency (Hz)	No	L (m)	I (Cm ⁴)	Load (kN/m)	Frequency (Hz)
1	0.6	80.1	5	31.95	51	1.7	1320	15	8.32
2	2	541	5	6.04	52	1.3	541	15	8.31
3	1.3	171	5	8.44	53	2	1940	15	6.8
4	1.7	318	5	6.09	54	1.1	318	15	9.41
5	2.4	869	5	5.37	55	1.6	1320	15	8.26
6	0.5	80.1	5	36.09	56	2.4	3890	15	7.04
7	1.3	171	5	8.36	57	1	318	15	11.62
8	1.5	318	5	8.07	58	2.1	2770	15	7.73
9	0.7	80.1	5	22.66	59	0.6	80.1	15	15.06
10	2.5	869	5	4.85	60	1	541	20	12.72
11	1.9	541	5	7.2	61	2.4	5790	20	6.59
12	2.3	869	5	5.85	62	2.5	5790	20	6.45
13	1.4	171	5	7.09	63	0.6	171	20	19.24
14	2.5	869	5	5.25	64	1.1	541	20	9.98
15	0.9	80.1	5	12.36	65	0.9	318	20	12.44
16	1	171	10	9.23	66	0.9	318	20	12
17	1.6	541	10	7.04	67	1.3	869	20	8.43
18	1.3	541	10	10.41	68	2.2	3890	20	6.59
19	1.5	541	10	8.53	69	1.7	1940	20	8.57
20	1.1	318	10	11.36	70	1.5	1320	20	7.81
21	2.5	1940	10	5.34	71	1.7	1940	20	7.68
22	1	171	10	10.54	72	1.9	2770	20	8.3
23	1.9	1320	10	7.17	73	2.2	3890	20	6.96
24	2	1320	10	6.88	74	1.8	1940	20	7.25
25	1.8	869	10	6.22	75	2.3	5790	20	7.84
26	1.9	869	10	6.26	76	1.8	2770	20	7.94
27	0.7	80.1	10	15.1	77	2.5	5790	20	6.51
28	0.9	171	10	11.74	78	1.9	2770	20	7.42
29	1.1	318	10	11.41	79	2	2770	20	6.69
30	1.2	318	10	9.19	80	0.9	541	25	13.21
31	1.5	541	10	7.82	81	1.9	3890	25	8.05
32	0.6	80.1	10	21.3	82	2.4	8360	25	7.74
33	1.3	318	10	8.63	83	1	541	25	12.09
34	2.3	1940	10	6.12	84	1.2	869	25	10.36
35	0.7	80.1	10	13.28	85	0.5	80.1	25	16.63
36	1.7	869	10	7.8	86	1.5	1940	25	8.64
37	0.8	171	10	14.27	87	1.1	869	25	10.53
38	0.8	171	15	12.98	88	2	3890	25	7.47
39	2.3	2770	15	5.93	89	1.6	1940	25	8.43
40	0.8	171	15	12.01	90	1	869	25	13.7
41	1.9	1940	15	7.03	91	1.7	2770	25	9.16
42	1.2	541	15	10.24	92	2.2	5790	25	7.01
43	1.8	1320	15	6.97	93	2.3	5790	25	7.33
44	1.9	1940	15	7.57	94	2.3	5790	25	6.29
45	0.9	318	15	15.39	95	1.2	1320	25	11.49
46	1.8	1940	15	8.48	96	1.9	3890	25	7.63
47	2.2	2770	15	6.49	97	2.1	5790	25	8.41
48	1.4	869	15	9.13	98	0.7	171	25	14.09
49	1.4	869	15	8.49	99	1.8	2770	25	7.91
50	1.6	1320	15	9.52	100	2.5	8360	25	6.72

The training and convergence of computed values from the ANN are illustrated in Figures 3 and 4 for fixed ends and cantilever beams, respectively. It is evident that the MSE of the ideal network started at a large value and eventually decreased to a small value. In other words, the proposed architecture behaved very well. The output plot has three lines as the input and target vectors are randomly divided into three sets.

Table 3. Networks with different numbers of hidden layers

Numbers of hidden layers	Fixed Beams		Cantilever Beams	
	MSE	Average training time (s)	MSE	Average training time (s)
1	9E-3	2.2	5.1E-4	2.2
2	9E-3	3.3	5.1E-4	3.3
3	8.99E-3	4.8	5.09E-4	4.9
4	8.99E-3	5.9	5.09E-4	5.9
5	8.99E-3	7.1	5.09E-4	7.2

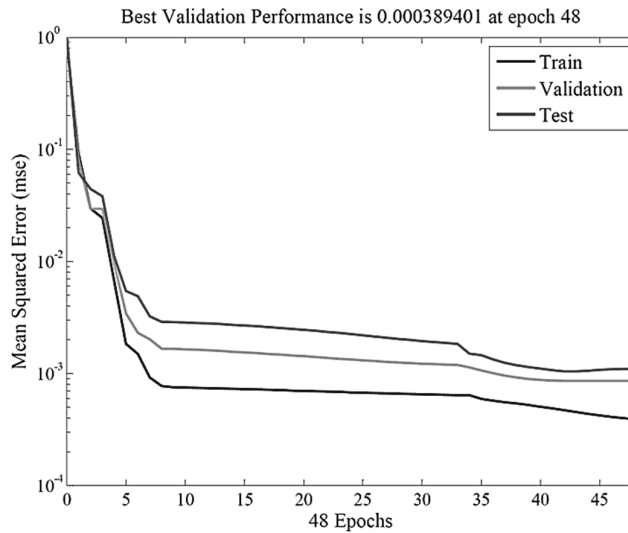

Figure 3. The performance of ANN for computed data for fixed ends beams

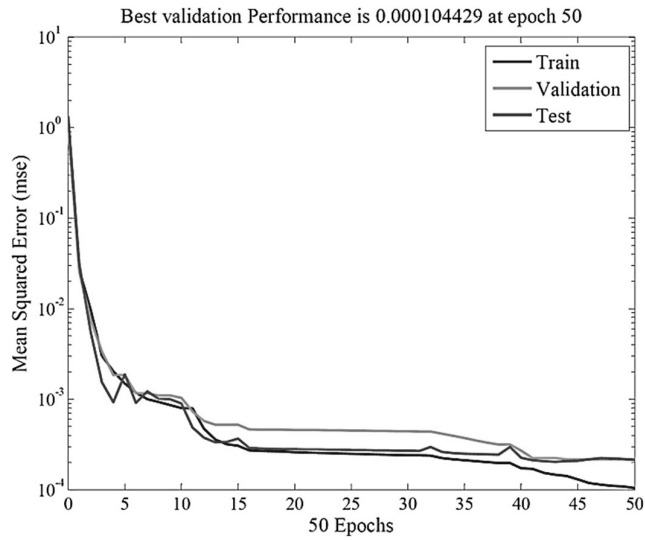

Figure 4. The performance of ANN for computed data for cantilever beams

Table 4. Networks with different numbers of neurons in the hidden layer

Numbers of neurons	Fixed Beams		Cantilever Beams	
	MSE	Average training time (s)	MSE	Average training time (s)
1	5.2E-2	0.39	1.75E-3	0.44
2	3.2E-2	0.68	8.90E-4	0.79
3	1.7E-2	1.19	7.35E-4	1.26
4	1.0E-2	1.69	6.93E-4	1.78
5	9.4E-3	2.05	5.74E-4	2.03
6	9.1E-3	2.13	5.12E-4	2.15
7	9.0E-3	2.21	5.09E-4	2.20
8	9.0E-3	2.36	5.09E-4	2.31
9	9.0E-3	2.84	5.08E-4	2.89
10	8.99E-3	3.19	5.08E-4	3.09

Figures 5 and 6 show the ANN regression analyses of training, validation and simulated test data ($0.9787 < R < 0.9956$). After the network memorizes the learning set, the training procedure is stopped. This technique automatically avoids the problem of over-fitting, which plagues many optimizations and learning algorithms.

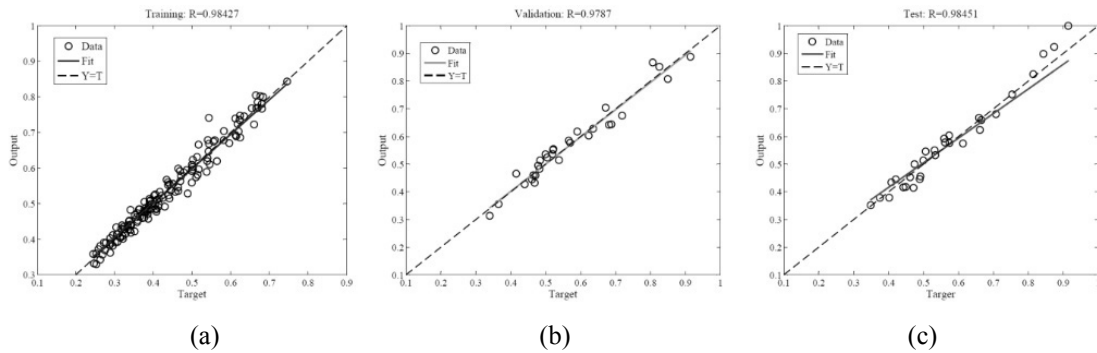

Figure 5. Regressions of (a) training, (b) validation, (c) simulated test data for two end fixed beams by ANN

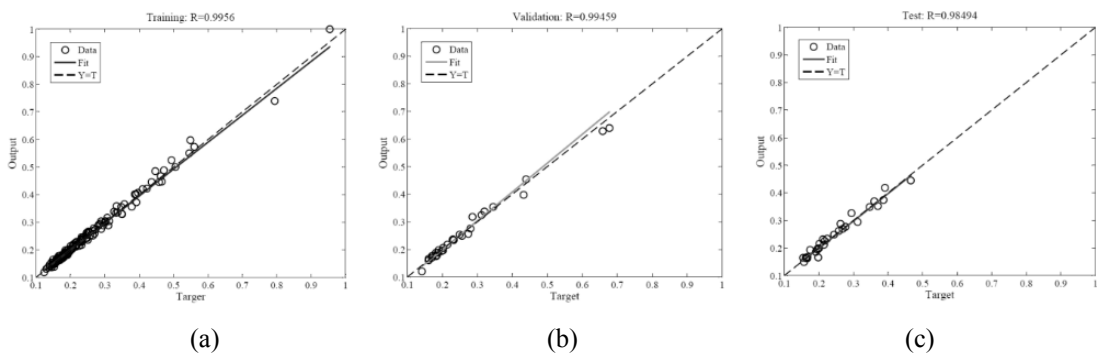

Figure 6. Regressions of (a) training, (b) validation, (c) simulated test data for cantilever beams by ANN

PREDICTING NATURAL VIBRATION FREQUENCY OF BEAMS WITH END FIXITIES

Due to the dependence of external data of ANN on the learning process, two different training and test data were used in this paper. The frequencies of 400 beams were predicted by the ANN, verified through FEM and code design provisions. The results are classified into five groups according to the applied force, P (kgf/m). Figures 7 and 8 show the results of the predicted values for fixed ends and cantilever beams, respectively.

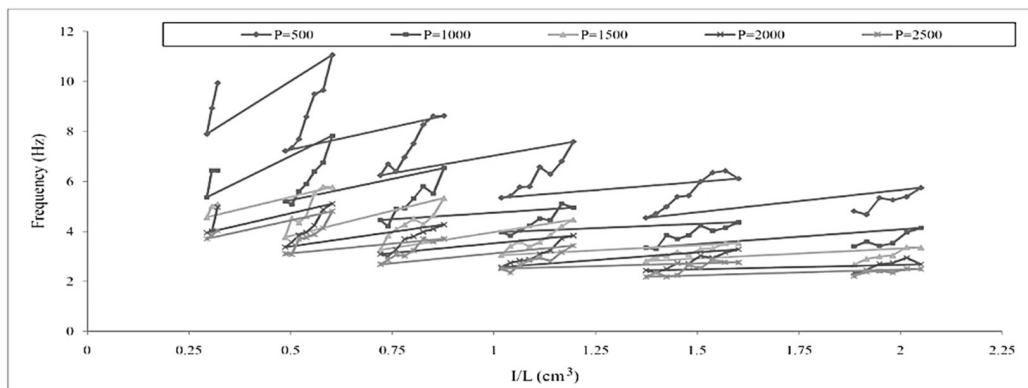

Figure 7. The computed natural frequency of fixed ends beams

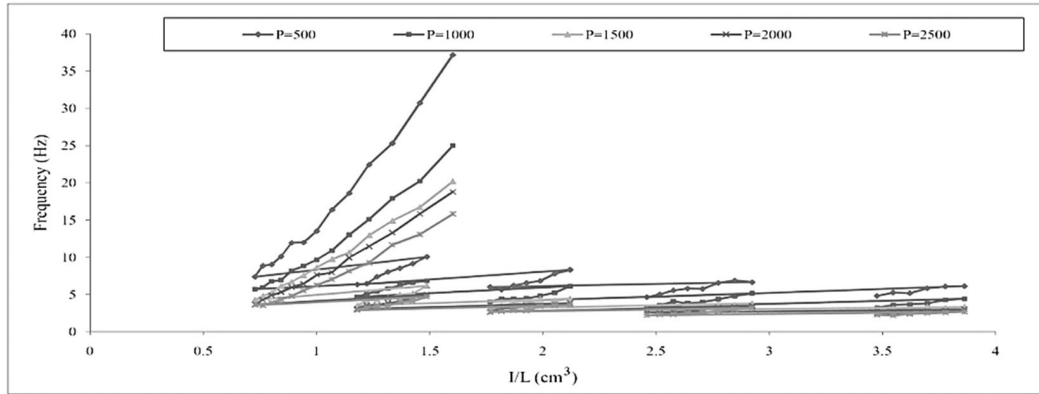

Figure 8. The computed natural frequency of cantilever beams

THE PROPOSED FORMULATION FOR NATURAL VIBRATION FREQUENCY CALCULATION

The frequency equations based on the total 600 beams combined of the FEM and ANN analyses are calculated. There are different methods for assigning a specific relationship for the distributed data; in which non-linear regression is one of the most widely applied methods. This regression includes various models such as linear, polynomial, exponential, logarithmic, power (exponential), etc. (Singh et al., 2009). According to Eq. 4, the nonlinear power regression model was used in Eq. 12.

$$f = \beta (I)^{A_1} (L)^{A_2} (P)^{A_3} \quad (12)$$

In this equation, β and A_i are the constant coefficients, I is the beam moment of inertia, L is the span length and P is the distributed load over the beam length. In order to compare the accuracy of the predicted regression, the MSE was calculated based on (Eq. 13).

$$MSE = \frac{1}{n} \sum (f_{FEM} - f_{Est.})^2 \quad (13)$$

Here, n is the number of assumed data by regression method, f_{FEM} is the natural frequency resulted from the FEM and $f_{Est.}$ is the estimated frequency by the proposed approach.

Implementing the above equations on the obtained results, the natural vibration frequency equations for fixed ends and cantilever beams are proposed in Eqns. 14 and 15, respectively:

$$f_{fixed} = 145 \sqrt{\frac{I}{PL^4}} \quad (14)$$

$$f_{cantiliver} = 23 \sqrt{\frac{I}{PL^4}} \quad (15)$$

Where I is the moment of inertia (cm^4), P is the applied load (kgf/m), L is the span length (m) and f is the natural vibration frequency (Hz). These two simple equations could be readily used by practicing engineers for design purpose considering different support conditions, rather than conducting complicated finite element simulations or analytical relations.

Finally, in order to further verify the accuracy of the proposed equations, the frequency of a new set of 100 fixed ends and cantilever beams, including different span length, moment of inertia and applied loads were calculated with both ANN and the proposed equations, checked against FEM. The mean square error values, between the obtained results from the proposed equations and ANN, are presented and compared in Figures 9 and 10.

The MSE from the proposed equation and ANN for the fixed ends beams are 0.12 and 0.07, respectively. These values for the cantilever beams are 1.08 and 0.092, respectively, indicating good conformity between the proposed solution and the predicted results.

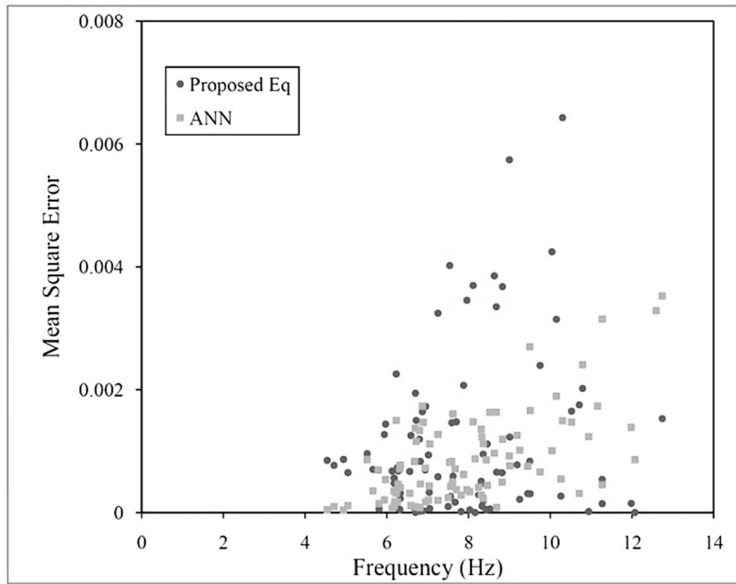

Figure 9. The difference between the MSE in the proposed equation and ANN for fixed end beams

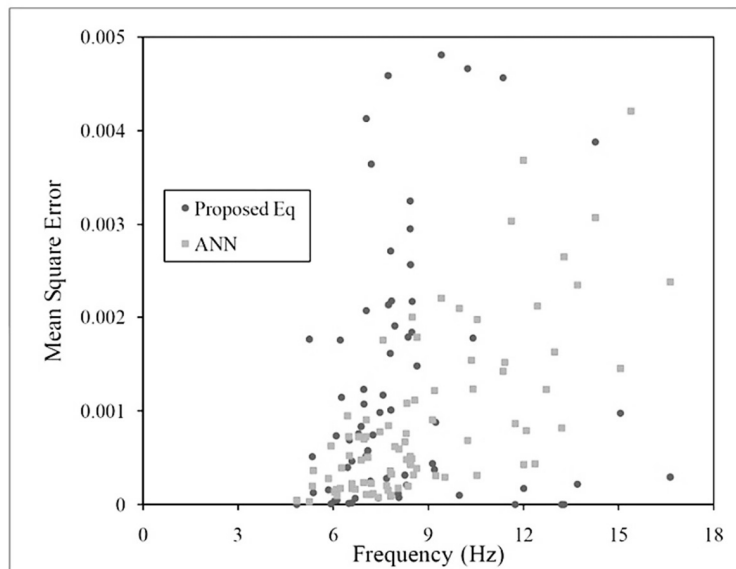

Figure 10. The difference between the MSE in the proposed equation and ANN for cantilever beams

CONCLUSION

The excessive floor vibration makes the residents inconvenient and increases the risk of structural damage. Furthermore, controlling the vibration is important while designing tall buildings. The natural vibration frequency of floor beams is an essential property to monitor and control this phenomenon. The structural design guidelines emphasize that the beams connected to large areas without beam partitions (or any other elements with the damping mechanism) should be controlled based on shaking and vibration of kinetic loads (walking, elevator movement, etc.). To control floor vibration, the floor should be designed in a way to have greater natural frequency compared to imposed vibration frequency. Due to the lack of practical relationship for estimating the natural vibration frequency of the steel beams, this study tried to propose two simplified equations for practicing engineers for fixed ends and cantilever beams to be included in next edition of structural design guidelines. These relationships were derived by incorporating nonlinear FEM and ANN. This method provided a versatile and powerful tool for handling a wide range of data analysis to derive vibration frequency formulations. The proposed vibration frequency equations include the moment of inertia, applied loading and beam length. The calculated frequencies for fixed ends and cantilever beams were respectively 2.07 and 0.33 times more than the natural vibration frequency of the simply supported beams with the same physical properties.

The current study has been focused on the hot-formed steel sections mainly used in the construction industry. A similar procedure can be performed on the cold-formed steel sections in future studies.

REFERENCES

- Abdel-Jaber, M.S., Al-Qaisia, A.A., Abdel-Jaber, M., & Beale, R.G. 2008.** Nonlinear natural frequencies of an elastically restrained tapered beam. *Journal of Sound and Vibration*, **313**(3-5): 772-783.
- Ahmed, K.M. 1971.** Free vibration of curved sandwich beams by the method of finite elements. *Journal of Sound and Vibration*, **18**(1): 61-74.
- AISC. 2005.** Specification for Structural Steel Buildings, American Institute of Steel Construction, Chicago.
- AISC. 2017.** Manual of Steel Construction: Load and Resistance Factor Design, Third Edition.
- Allen, D. E., & Pernica, G. 1998.** Control of floor vibration. Ottawa, ON, Canada: Institute for Research in Construction, National Research Council of Canada.
- ANSYS User's Manual. 2016.** Houston: Swanson Analysis Systems Inc.
- Bigdeli, Y., & Kima, D. 2017.** Development of energy based Neuro-Wavelet algorithm to suppress structural vibration. *Structural Engineering and Mechanics*, **62**(2): 237-246.
- Billig, J. 1979.** Estimation of the natural frequencies of continuous multi-span bridges. Research report 219. Ontario (Canada): Ontario Ministry of Transportation and Communications. Research and Development Division.
- CSA. 1989.** Canadian Standards Association, Guide for floor vibrations. CSA Standard CAN 3-S16.1-89. Steel structures for buildings-limit state design.
- Duan, H. 2008.** Nonlinear free vibration analysis of asymmetric thin-walled circularly curved beams with open cross section. *Thin-Walled Structures*, **46**(10): 1107-1112.
- Gorman, D.J. 1990.** A general solution for the free vibration of rectangular plates resting on uniform elastic edge supports. *Journal of Sound and Vibration*, **139**(2): 325-335.
- Heins, C. P., & Sahin, M. A. 1979.** Natural frequency of curved box girder bridges. *Journal of the Structural Division*, **105**(12).
- Keskin, R. S. 2017.** Predicting shear strength of SFRC slender beams without stirrups using an ANN model. *Structural Engineering and Mechanics*, **61**(5), 605-615.
- Leissa, A.W. 2005.** The historical bases of the Rayleigh and Ritz methods. *Journal of Sound and Vibration*, **287**(4-5): 961-978.
- Middleton, C.J., & Brownjohn, J.M.W. 2010.** Response of high frequency floors: A literature review. *Engineering Structures*, **32**(2): 337-352.

- Moré, J.J. 1978.** The Levenberg-Marquardt algorithm: implementation and theory. In Numerical analysis (pp. 105-116). Springer, Berlin, Heidelberg.
- Naeim, F. 1991.** Design practice to prevent floor vibrations. Steel Committee of California.
- Naderpour, H., Nagai, K., Fakharian, P. and Haji, M. 2019.** Innovative models for prediction of compressive strength of FRP-confined circular reinforced concrete columns using soft computing methods. *Composite Structures*, **215**: 69-84.
- Nandi, A.K., & Azzouz, E.E. 1998.** Algorithms for automatic modulation recognition of communication signals. *IEEE Transactions on communications*, **46**(4): 431-436.
- Nguyen, C.T., Moon, J., & Lee, H.E. 2011.** Natural frequency for torsional vibration of simply supported steel I-girders with intermediate bracings. *Thin-Walled Structures*, **49**(4): 534-542.
- Przybylski, J. 2009.** Non-linear vibrations of a beam with a pair of piezoceramic actuators. *Engineering Structures*, **31**(11): 2687-2695.
- Sanchez, T.A., & Murray, T.M. 2010.** Experimental and analytical study of vibrations in long span deck floor systems. In *Structures Congress 2010*, 914-925.
- Singh, V.P., Chakraverty, S., Sharma, R.K., & Sharma, G.K. 2009.** Modeling vibration frequencies of annular plates by regression based neural network. *Applied Soft Computing*, **9**(1): 439-447.
- Soedel, W. 1982.** On the natural frequencies and modes of beams loaded by sloshing liquids. *Journal of Sound and Vibration*, **85**(3): 345-353.
- Veletsos, A.S., & Newmark, N.M. 1955.** Natural frequencies of continuous flexural members. In *Selected Papers By Nathan M. Newmark: Civil Engineering Classics* (pp. 529-566). ASCE.
- Wang, J., Liu, W., Wang, L., & Han, X. 2015.** Estimation of main cable tension force of suspension bridges based on ambient vibration frequency measurements. *Struct. Eng. Mech*, **56**: 939-957.
- Yamada, Y., & Veletsos, A.S. 1958.** Free vibration of simple span I-beam bridges. Eight progress report. Highway bridge impact investigation. UIUC.
- Yoon, K.Y., Park, N.H., Choi, Y.J., & Kang, Y.J. 2006.** Natural frequencies of thin-walled curved beams. *Finite Elements in Analysis and Design*, **42**(13): 1176-1186.
- Živanović, S., Pavic, AL., & Reynolds, P. 2005.** Vibration serviceability of footbridges under human-induced excitation: a literature review. *Journal of sound and vibration*, **279**(1-2): 1-74.