

Power improvement in PV panel under temperature variation fault using refrigeration mechanism and its implementation

Samima Akter, Saptadip Saha and Priyanath Das

Dept. of Electrical Engineering, National Institute of Technology Agartala, India

Email: samima.akter1989@gmail.com, Corresponding Author

ABSTRACT

The output power characteristics of solar photovoltaic (PV) system are governed by irradiance (G) and temperature (T) of ambient environment. As per standard testing conditions (STC) when the PV panel temperature is 25°C, the PV system delivers the maximum power. With the rise of each °C in temperature, the efficiency of output power is dropped by approx. 1%. This paper proposes the analysis of the effect of fault due to temperature variation on PV system and also suggests a practical technique about the cooling of PV panels to increase the output power. A model was designed in Electromagnetic Transient Design and Control/Power Systems Computer Aided Design (EMTDC/PSCAD) considering the scenario where there is a change in temperature and accordingly the performance was analysed. The simulated model was then examined with the practical setup. Among two panels, the first panel is considered (without cooling) as a reference for comparison and the second panel is considered with cooling to study the enhancement in the performance of the PV panel. The temperature of the PV panel is controlled by water coolant using water soaked jute bag on the back side of the panel. The variation of the power–voltage (P-V) curve, current–voltage (I-V) curve, open circuit voltage profile, short circuit current, maximum power and percentage of power profile due to the effect of fault during temperature variation on PV panel without refrigeration mechanism, and the improvement in power due to cooling have been studied using both simulation and experiment for five sets of data. The experimental setup is installed on the rooftop of G+6 block of the National Institute of Technology Agartala for the validation of the proposed scheme.

Keywords: Fault analysis, photovoltaic panel, temperature variation, PSCAD, cooling, solar irradiance.

INTRODUCTION

In modern days, renewable energy is extensively promoted by many countries for generation of power. Solar energy plays a major role among all the renewable sources, as it is more realistic and reliable. Since the output characteristics of PV system are dependent of certain environmental parameters, analysis of performance and stability is a great concern. In the solar PV system, solar energy can be directly converted to electrical energy without any mechanical and thermal link. This electric power, generated from solar systems, can be utilized with less transmission and distribution losses. Photovoltaic (PV) cell is one of the most basic components in PV panel. The performance characteristic curve of PV system directly varies with environmental conditions such as solar irradiance, panel temperature, and spectrum. PV cell converts 15% solar radiation into electrical energy with the rest being transferred into heat energy (Tian et al., 2013; Maghami et al., 2016; Francis et al., 2016; Hasan et al., 2016). Electricity produced by the solar panel is a product of the level of sunlight and ambient air temperature (Teo et al., 2012; Makrides et al., 2012; Hill et al.). The performance of PV system decreases with the increase in solar panel temperature due to various losses in the individual PV cell (Khan et al., 2016). To mitigate this problem and to enhance system performance various cooling methodologies were considered by several researchers. Cooling and heating performances of the solar panel were analysed in detail in a small-scale experimental system and the effects of air gap and coatings were also studied by Yong et al. (2015). Davidson et al. (2014) presented solar heating and cooling techniques that reflect the ridiculous history of the relationship between heating and cooling.

The performance analysis of solar cells during temperature variation was shown by Tobnaghi et al. (2013); Xiao et al. (2014); Singh et al. (2012). The open circuit voltage (V_{oc}) decreases linearly with the increase in temperature of the PV cell/panel and vice versa, whereas the current, marginally, increases with the increase in temperature (Khan et al., 2013). Byrne et al. (2015) reviewed the articles on PV panel refrigeration techniques. The capacity of coupling purification skills for cooling systems was also calculated. Different cooling techniques of PV panel were investigated by Rustemli et al. (2013) to increase the output power, voltage profile, and system efficiency. It was also observed that installed photovoltaic panels nearest to seaboard can be used more effectively.

Bell et al. (2008) analysed the thermo-electric material properties and discussed about solid-state energy converters to convert waste heat into electricity. Ullah et al. (2013) presented an overview on different solar thermal refrigeration systems based on various working fluids. Ceylan et al. (2014) calculated the PV module temperature in a different region of turkey for getting maximum electrical efficiency and output power. Anand et al. (2015) offered a review article on solar panel cooling techniques. A mathematical model of a vapour compression refrigeration (VCR) system for optimising the dynamic performance of the system was shown by Nunes et al. (2015). Hamdeh et al. (2010) developed a prototype solar adsorption refrigeration unit for remote areas.

Ghafoor et al. (2015) showed an overview of solar thermal driven technologies that are used for cooling and air-conditioning purposes. Zeyghami et al. (2015) discussed a brief idea about solar thermo-mechanical refrigeration and cooling methods for solar panels. An increase in temperature in the solar module is one of the main challenges for photovoltaic systems, which cause a significant reduction in the PV performance. Najafi et al. (2013) proposed a new cooling technique using Peltier effect. This technique can keep the PV module temperature at the optimum level. Askalany et al. (2012) analysed the hybrid adsorption cooling systems. It was possible to make cool and clean PV panels to obtain better performance using water cooling as suggested by Moharram et al. (2013).

If the PV panel operating temperature increases, then PV panel power–voltage (P–V) curve shows degradation in characteristics; open circuit voltage profile, the percentage of improvement of power, and maximum power point also decrease but short circuit current increases. The photovoltaic panel performance can be maintained by controlling temperature using cooling or PV panel refrigeration technique. In this paper water is used as a coolant, which has very high heat dissipation and heat exchange capacity. The low cost of water as coolant and also the marginal cost of the overall arrangement motivated the work. Jute bags soaked with water were used to cool the panel from back side covering the maximum surface area.

A brief summary of the paper: Different issues in solar panel or array are presented in the introduction. A discussion was done about the solar panel problem in Section 2. A solution considering the temperature effect on PV panel is introduced in the solution approach section. Simulation and experimental details are shown in results and discussions section. The conclusion is presented in the last section of this paper.

THEORETICAL

Single diode model

The single diode model of PV cells is shown in Fig. 1. The equations related to PV cell are written below:

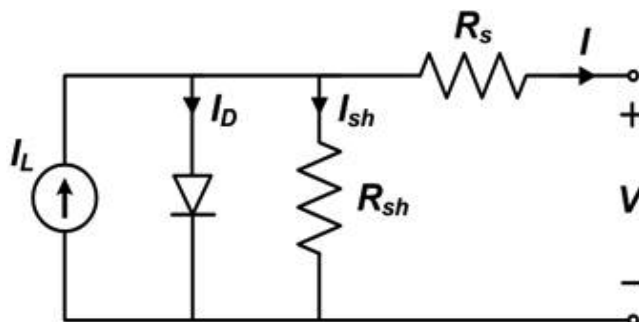

Fig. 1. A single diode model representation of a typical solar cell (Tian et al., 2013)

$$I = I_L - I_0 \left[\exp\left(\frac{V + IR_s}{\eta V_T}\right) - 1 \right] - \frac{V + IR_s}{R_{sh}} \quad (1)$$

$$I_D = I_0 \left[\exp\left(\frac{V + IR_s}{\eta V_T}\right) - 1 \right] \quad (2)$$

$$V_T = \frac{KT_c}{q} \quad (3)$$

where I_L = Light Current (A); I_D = Diode current; I_0 = Diode Reverse Saturation Current (A); R_{sh} = Shunt Resistance (Ω); R_s = Series Resistance (Ω); K = Boltzmann's constant; V_T = Thermal Voltage (V); η = Diode Ideality Factor = 1.5

If N_s numbers of cells are connected in series in PV panel, then equations related to PV panel are given below:

$$I = I_L - I_0 \left[\exp\left(\frac{V_P + I_P N_s R_s}{\eta N_s V_T}\right) - 1 \right] - \frac{V + IR_s}{N_s R_{sh}} \quad (4)$$

$$I_D = I_0 \left[\exp\left(\frac{V_P + I_P N_s R_s}{\eta N_s V_T}\right) - 1 \right] \quad (5)$$

$$V_T = \frac{KT_c}{q} \quad (6)$$

The light current (I_L) is shown below in (Tian et al., 2013; Hu et al., 2013)

$$I_L = I_{L,ref} \left(\frac{G}{G_{ref}} \right) \left[1 + \alpha'_T (T_{cell} - T_{cell,ref}) \right] \quad (7)$$

where $I_{0,ref}$ is the light current at standard reference conditions (SRC), α'_T is the relative temperature coefficient of the short-circuit current, Solar reference irradiation = 1000 W/m^2 , G is the actual irradiance of the PV panel.

Diodes reverse saturation current (I_0) is given below:

$$I_0 = I_{0,ref} \left(\frac{T}{T_{ref}} \right)^3 \exp \left[\frac{E_{g,ref}}{kT_{ref}} - \frac{E_g}{kT} \right] \quad (8)$$

where $I_{0,ref}$ = diode saturation current at SRC, E_g is the band-gap energy (eV).

for E_g silicon is expressed by

$$E_g(T) = E_g(0) - \frac{\alpha T^2}{T + \beta} \quad (9)$$

where $E_g(0) = 1.103$ eV, $\alpha = 4.730 \times 10^{-4}$ eV/K, $\beta = 636$ K.

When PV panels are connected in series for building a PV array or PV system (PVS) more power will generate.

Effect of fault due to temperature variation in PV panel

The performance of PV system varies with an increase in PV panel surface temperature as most of the incident radiation is converted into heat. To achieve the higher electrical performance of the PV system PV panel should be cooled by extracting the extra heat from the panel assembly in some way as the short circuit current increases slightly with increasing temperature; the open circuit voltage decreases with increasing temperature, leading to a reduction of electrical power of solar panel.

The photovoltaic panel temperature T_p is calculated using the following well-known equation (Askalany et al., 2012):

$$T_P = T_{amb} + \frac{(NOCT - 20)E}{800} \quad (10)$$

where panel temperature depends on solar irradiance (i.e. E); T_{amb} is ambient temperature; $NOCT$ = nominal operating cell temperature.

The $NOCT$ is a function of the ambient air temperature at the sunrise time T_{rise} as follows:

$$NOCT = 20^\circ C + T_{rise} \quad (11)$$

In the above-mentioned way, the panel is working at lower temperatures (higher efficiency) and the thermal energy gained in the form of hot water can be utilised for domestic applications. From both the simulation and experimental results, it is obtained that P-V curve, maximum output power, open circuit voltage, and the percentage of improvement of power dropped prominently because of the PV panel temperature variation.

Problem formulation

The temperature increment is the most important issue of a PV panel in PV system. It causes a significant reduction in maximum output power, open circuit voltage, efficiency, and percentage of improvement of power since most of the incident radiation is converted into heat. Electricity produced by the PV panel is inversely affected by their operating temperature, which is the product of the level of sunlight and ambient air temperature.

Sunlight length and strength are two important things on which PV panel's performance depends. To minimize the effect of temperature increment, different cooling methods are considered to control panel temperature.

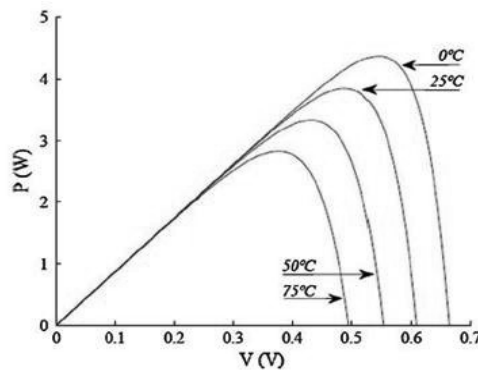

Fig. 2. P-V graph with temperature variation from to of one PV panel

Fig. 2 shows the characteristics of voltage and power with variations of temperature and it is clearly observed that, with the increase in temperature, both power and voltage are decreased as found in Hill; Askalany et al. (2012); Moharram et al. (2013).

Solution approach

The detailed methodology is discussed below:

Proposed technique

Using water as a coolant, we tried to reduce the temperature of the panel. We have used jute bag soaked with water to cool the panel from back side covering the maximum surface area. The reservoir is connected to the jute bag from the back of the panel. The used surplus water is fed to the reservoir. It is used as a storage medium. The water pumped back to the duct from the reservoir by a water pump. Water duct drops the water to the jute bag to cool the panel and the process continues. The block diagram of the proposed scheme is shown in Fig. 3. The advantages of the proposed scheme with compared to the available cooling schemes are tabulated in Table 1.

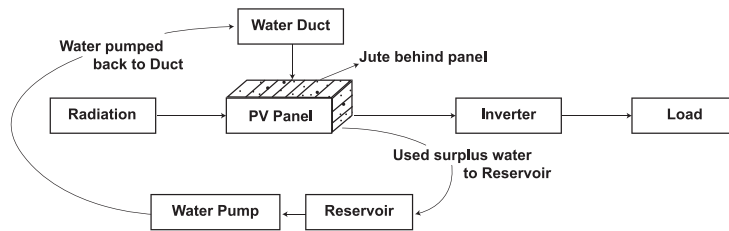

Fig. 3. Block diagram of the proposed technique

Table 1. Comparative analysis of the proposed scheme with other available schemes.

References	Coolant used	Remarks
S. Rustemli et al. (2013)	Water as a coolant	No proper cooling mechanism
T. K. Nunes et al. (2015)	Water vapor as a coolant	More water is required. So, it is not cost effective
N. H. A. Hamdeh et al. (2010)	The carbon used as adsorbents with methanol to form an adsorbent-adsorbate paper.	Suitable only for remote areas. Experimental set-up is costly including the piping cost
M. Zeyghami et al. (2015)	Solar ejector cooling system (SECS)	Required time is more due to three circulating loops in SECS, More complex experimental set-up.
H. Najafi et al. (2013)	PV cell cooling technique	Costly due to lot of cells and aluminum sheet
A. Askalany et al. (2012)	Vapour compression with adsorption employing activated carbon/ pair for cooling	Costly
K. A. Moharram et al. (2013)	Water used as coolant	Experimental set-up is costly, Water spraying on the front surface of the PV panel is required after every 15 minutes, More water is required
Proposed scheme	Water used as a coolant	Reuse of surplus water, cost effective, easy experimental setup, continuous cooling effect

Simulation details

A simulation study has considered EMTDC/PSCAD software; the simulation part is done by using the proposed model, which is shown in Fig. 4.

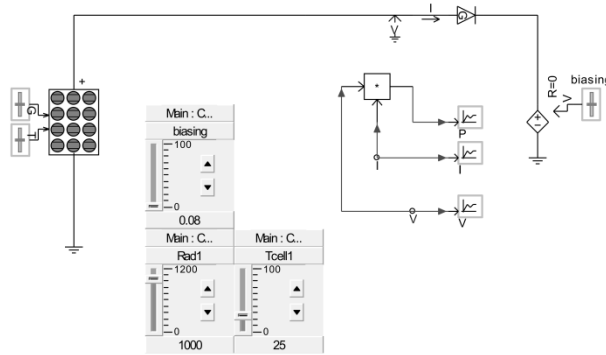

Fig. 4. Simulation model of single PV panel at Standard Test Conditions (STC) - $G = 1000 \text{ W / m}^2$; $T = 25^\circ\text{C}$

The effect of fault due to temperature variation on PV panel at different solar irradiation and different panel temperature without cooling (woc) and with cooling (wc) is analysed in different ways. These are by analysing power-voltage characteristic curve, open circuit voltage profile (V_{OC}), current-voltage characteristic curve, short circuit current (I_{SC}), maximum power point (P_{max}) and percentage of improvement of power.

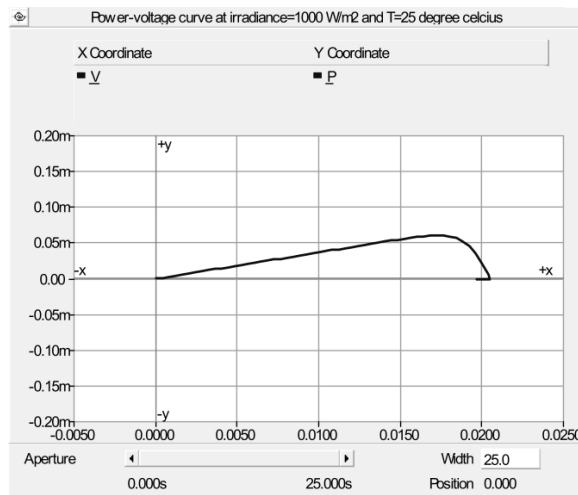

Fig. 5. One panel P-V graph in simulation at STC ($G = 1000 \text{ W / m}^2$; $T = 25^\circ\text{C}$)

Figure 5 shows the power-voltage profile at Standard Test Conditions (STC). In PSCAD software inbuilt power and voltage unit are MW and KV, respectively. So, from the above graph, it is observed that open circuit voltage (V_{OC}) is 20 volt and maximum power point (P_{max}) is 60 watt.

EXPERIMENTAL SET-UP DETAILS

Two 60 W single photovoltaic panels (Akshaya solar power) are considered in this study. This work is based on the analysis of the fault due to temperature variation on photovoltaic (PV) system subject to increase of temperature in one panel and reduces of temperature using cooling for the other panel. A voltmeter and an ammeter are connected in parallel and series with each of the panels. A rheostat is connected in series with the panel.

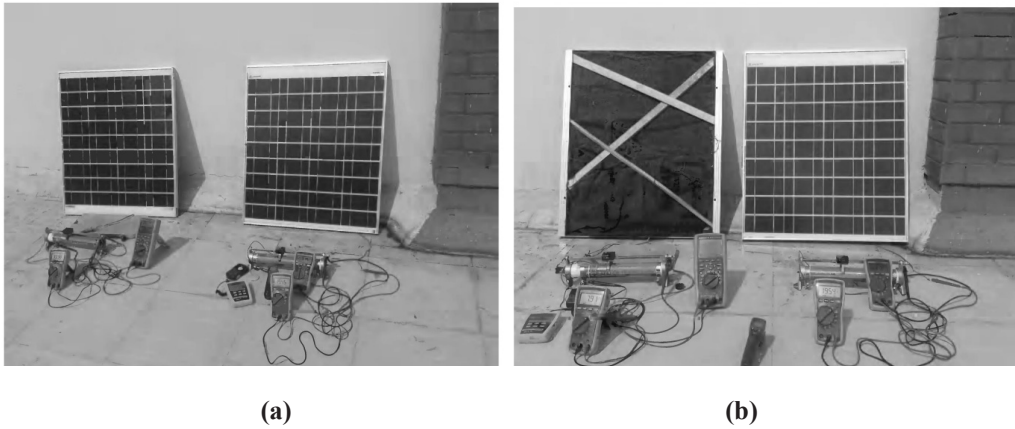

Fig. 6. Experimental setup (a) with and without cooling (front side) (b) with cooling (back side) and without cooling (front side)

Now, the resistance is varied and the corresponding voltage and current are noted down for both the panels without cooling (*woc*) and with cooling (*wc*) at a time. Different data sets are taken at different temperatures at the different time of the particular day. A Lux meter and a Pyranometer are used to measure the light intensity and irradiance, respectively. An infrared thermometer is used to measure the cell temperature. The outdoor experimental set-up is installed on the rooftop of G+6 block of National Institute of Technology Agartala as shown in Fig. 6.

RESULTS AND DISCUSSION

Simulated and experimental results without cooling (*woc*) and with cooling (*wc*) are discussed in the following subsections.

Simulation results with and without cooling

Simulating the proposed model in PSCAD/EMTDC at the same solar irradiance and different temperature at a time, many sets of data are taken on a particular day for analysis the impact of increase and decrease of solar panel temperature for the same irradiance at a time. Performance of PV panel open circuit voltage profile, power-voltage (P-V) curve, current-voltage (I-V) curve, maximum power profile, and improvement in percentage of power are analysed, which are shown below.

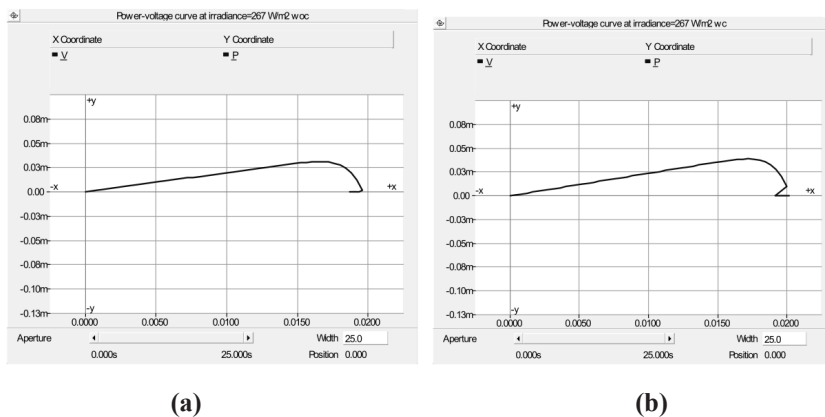

Fig. 7. Power-voltage curve at Irradiance = 267 W/m^2 in simulation (a) without cooling and (b) with cooling

From Fig. 7 (b), it is obtained that power flow through the PV panel after using cooling mechanism is more about 7.64 watt and voltage profile increases about 0.66 volt at 23°C as compared to that without cooling at 38°C during PV panel temperature variation at Irradiance = 267 W/m².

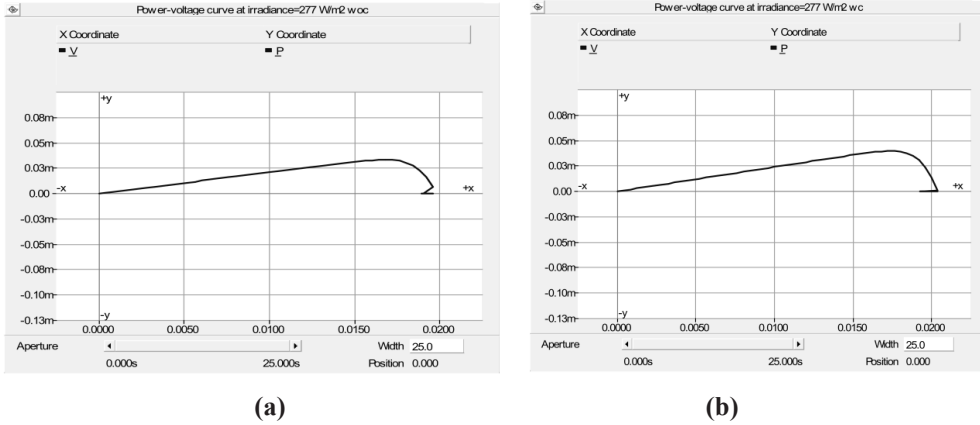

Fig. 8. Power-voltage curve at Irradiance = 277 W/m² in simulation (a) without cooling and (b) with cooling

Figure 8 (b) clearly shows that power profile and voltage profile improvement are about 6.31 W and 0.64 V, respectively, after considering the PV panel refrigeration procedure and panel temperature decreases from 35°C to 22°C. Graph 8(b) shows that power achieved with cooling is more compared to that without cooling.

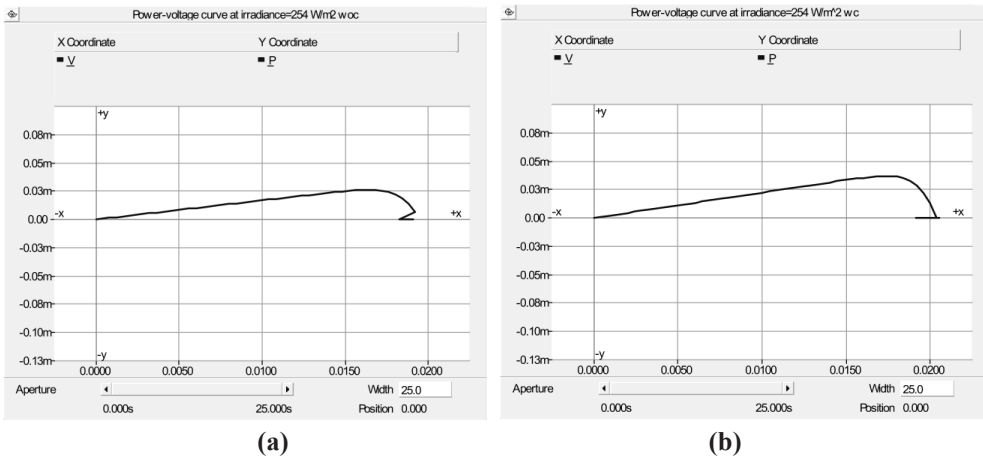

Fig. 9. Power-voltage curve at Irradiance = 254 W/m² in simulation (a) without cooling and (b) with cooling

From Fig. 9 (b), it is observed that there is an improvement in power profile, 10.76 W, and open circuit voltage profile, 0.99 V, compared to Fig. 9 (a) when the cooling technique is considered with PV panel during temperature variation in solar panel. It is also observed that temperature decreases from 40°C to 22°C with cooling at Irradiance = 254 W/m².

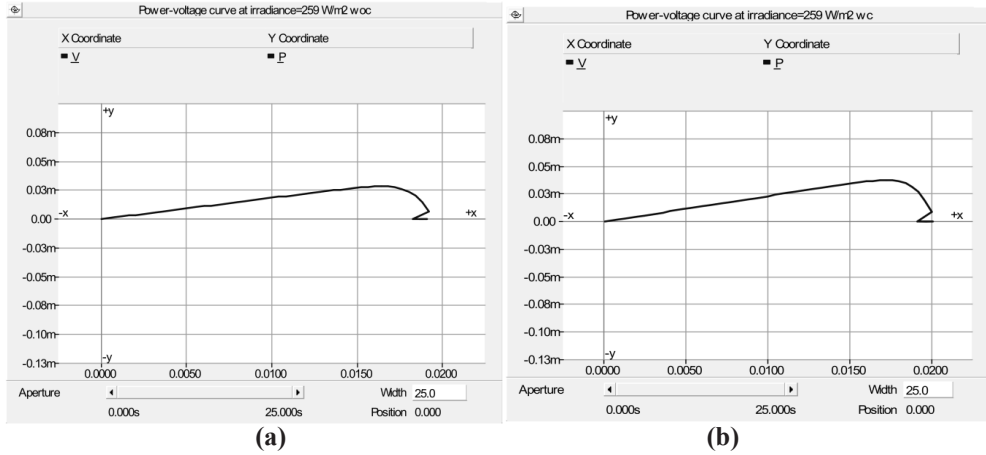

Fig. 10. Power-voltage curve at Irradiance = 259 W/m^2 in simulation (a) without cooling and (b) with cooling

Power and voltage obtained by Irradiance = 259 W/m^2 using cooling scheme with PV panel are more compared to that without cooling observed from Fig. 10 (b). Temperature decreases from 43°C to 23°C due to the PV panel refrigeration. Power and voltage increase, 9.19 W and 0.88 V , respectively, for the proposed coolant mechanism.

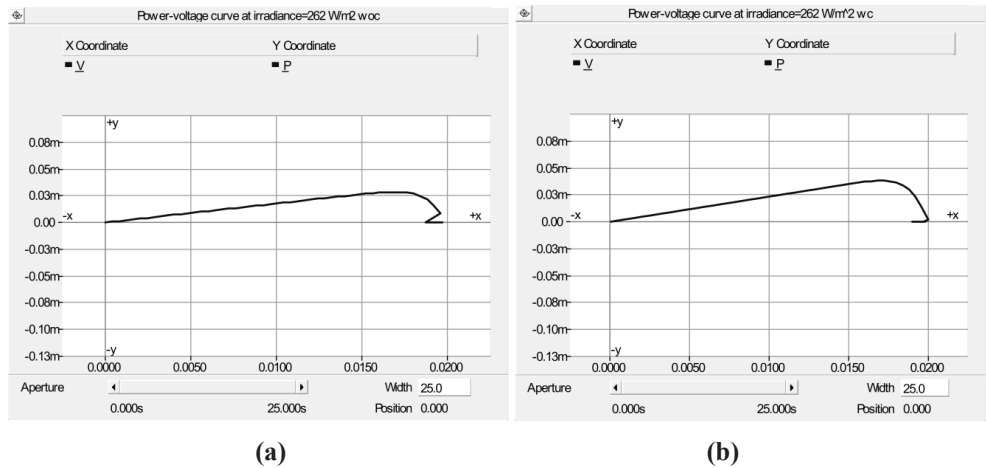

Fig. 11. Power-voltage curve at Irradiance = 262 W/m^2 in simulation (a) without cooling and (b) with cooling

Graphs of Fig. 11 (b) also show the superiority of the proposed refrigeration method during a fault in PV panel due to temperature variation in the photovoltaic panel at Irradiance = 262 W/m^2 and temperature decreases from 32°C to 26°C . Maximum power profile varies from 28.47 W to 38.14 W and voltage profile varies from 19.26 V to 19.47 V for the proposed cooling scheme.

From the obtained five sets of data at irradiance = 267 W/m^2 , 277 W/m^2 , 254 W/m^2 , 259 W/m^2 , 262 W/m^2 , current-voltage (I-V) curve during temperature variation in solar panel is analysed below:

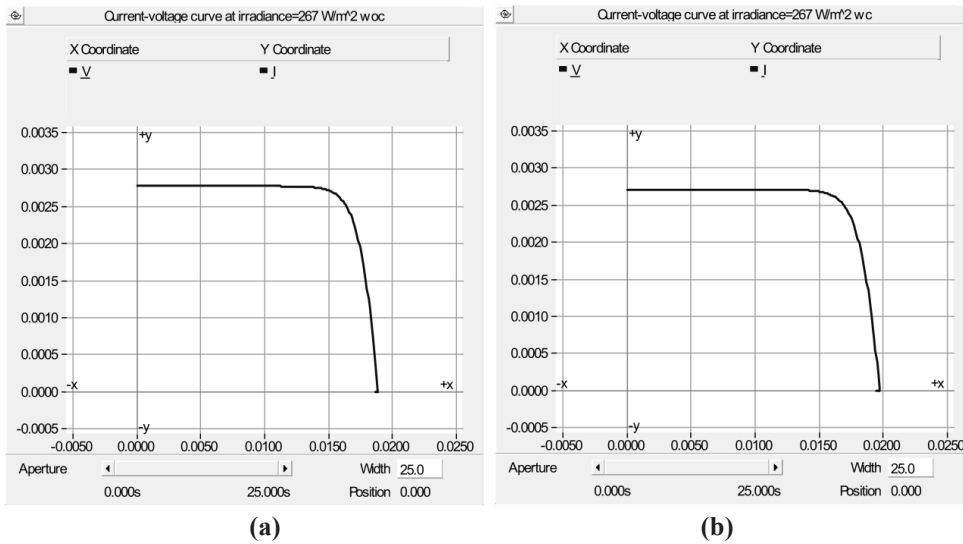

Fig. 12. Current-voltage curve at Irradiance = 267 W/m^2 in simulation (a) without cooling and (b) with cooling.

The above graph shows that the short circuit current is decreased from 2.73 amp to 2.71 amp with cooling and open circuit voltage will improve from 19.04 volt to 19.63 volt after connecting cooling mechanism in PV panel for decreasing solar panel temperature from 38°C to 23° .

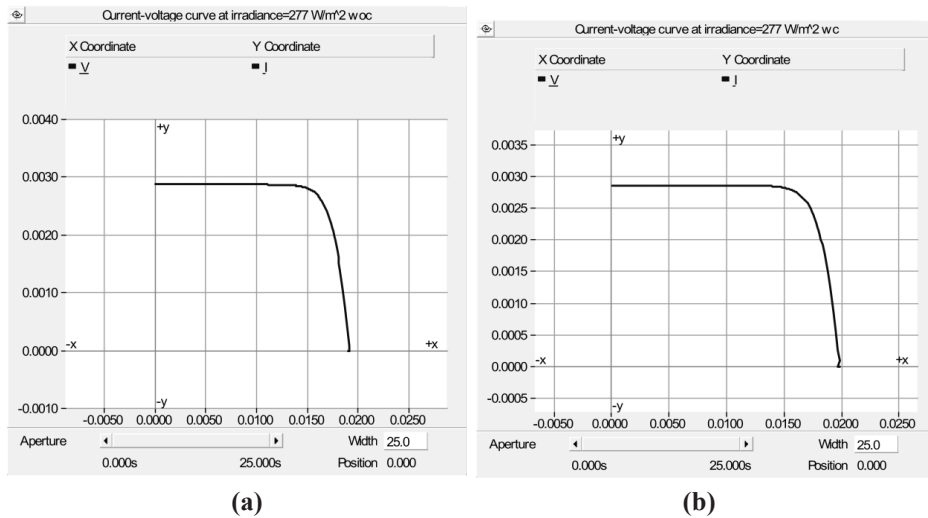

Fig. 13. Current-voltage curve at Irradiance = 277 W/m^2 in simulation (a) without cooling and (b) with cooling.

It is observed from Fig.13 that after connecting proposed cooling methodology temperature decreases from 35°C to 22° and there is an improvement in open circuit voltage about 0.92 V and decrement in short circuit current is 0.02 A during fault in PV panel due to temperature variation.

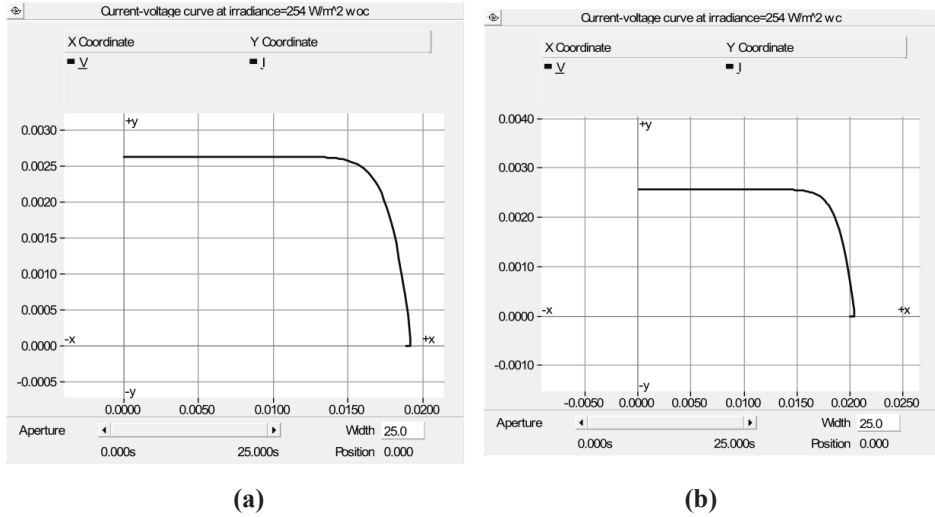

Fig. 14. Current-voltage curve at Irradiance = 254 W/m^2 in simulation (a) without cooling and (b) with cooling.

Nature of current-voltage curve for irradiance = 254 W/m^2 during temperature variation in the simulation without cooling and with cooling is illustrated in Fig. 14 (a) and Fig. 14(b). It is obtained that open circuit voltage improved about 1.02 volt and short circuit current decreases 0.05 amp after considering refrigeration mechanism with the faulted PV panel. Temperature decreases from 40°C to 22°C to due to proposed PV panel coolant technique.

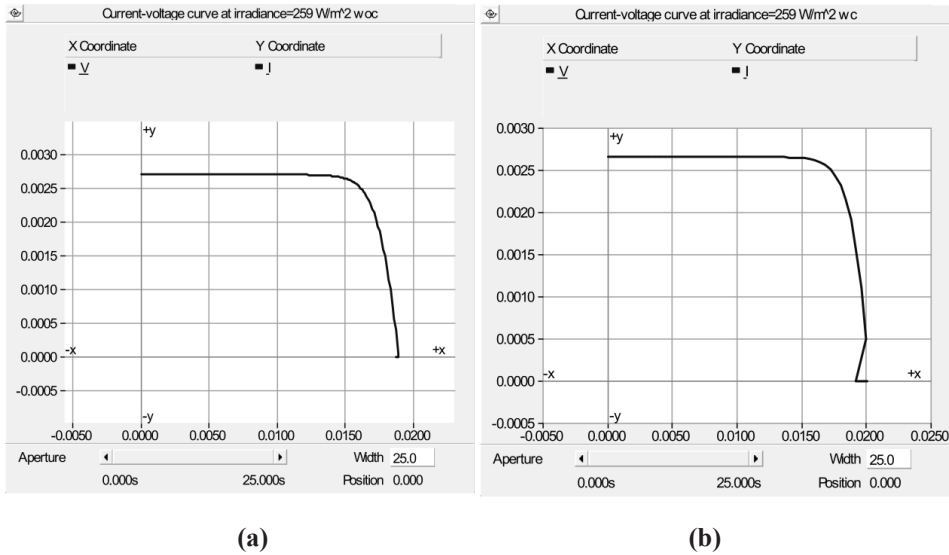
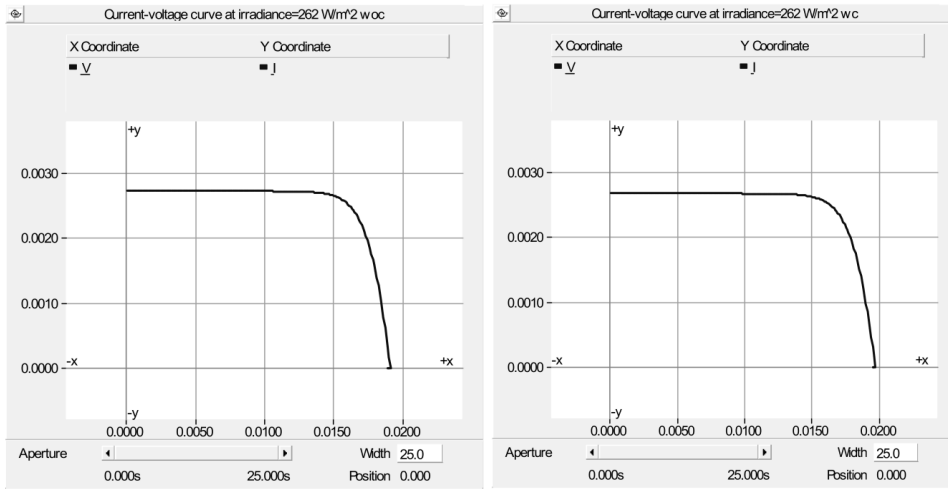

Fig. 15. Current-voltage curve at Irradiance = 259 W/m^2 in simulation (a) without cooling and (b) with cooling

It is also obtained from the above Fig. 15 that short circuit current (I_{SC}) decreases from 2.70 amp to 2.65 amp and open circuit voltage (V_{OC}) increases from 18.80 volt to 19.70 volt when PV panel temperature reduced from 40°C to 23°C considering the proposed PV panel coolant technique.



(a)

(b)

Fig. 16. Current-voltage curve at Irradiance = 262 W/m^2 in simulation (a) without cooling and (b) with cooling

The above graph shows the behaviour of current and voltage without and with refrigeration technique during PV panel temperature variation from 32°C to 27° . It is also seen from Fig. 16 that I_{SC} decreases about 0.05 A and V_{OC} increases 0.55 V when the cooling mechanism is considered with PV panel.

Experimental results

Two 60W solar panels are considered to analyse the effect of fault due to temperature variation without cooling (woc) and with cooling (wc) in outdoor. The P-V profile, improvement of maximum power profile, (P_{max}) open circuit voltage (V_{OC}), and increase in percentage of power are studied in this paper. For this analysis five different sets of data are collecting from practical set-up model installed on the rooftop of G+6 block of NIT Agartala campus in different time of a particular day.

Figure 17 shows that the improvement in power profile is 8.29 W as well as the voltage profile is 1.3 V of the photovoltaic panel after applying PV panel refrigeration technique compared to that without considering the proposed coolant mechanism by decreasing panel temperature from 38°C to 23° to at Irradiance = 267 W/m^2 .

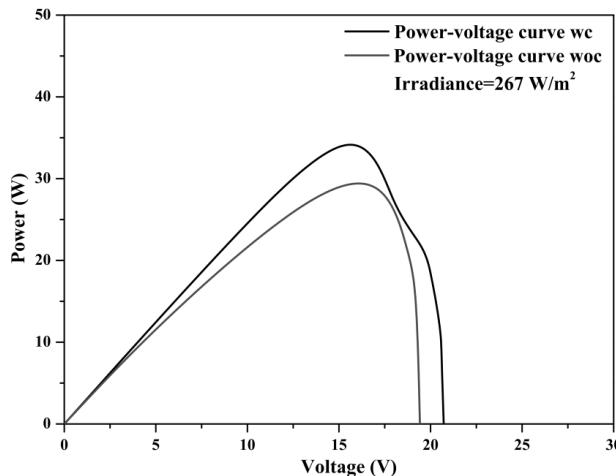

Fig. 17. Power-voltage curve at Irradiance = 267 W/m^2 in real time with cooling and without cooling.

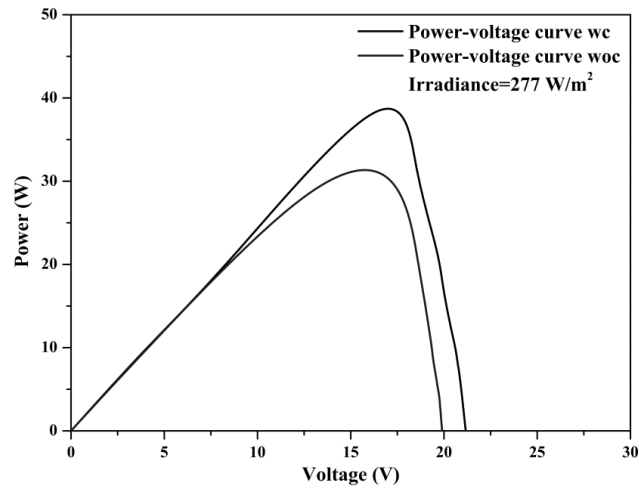

Fig. 18. Power-voltage curve at Irradiance = 277 W/m^2 in real time with cooling and without cooling.

The graphs plotted with and without considering cooling technique at Irradiance = 277 W/m^2 are shown in Fig. 18. The temperature of PV panel decreases from 35°C to 22° after applying cooling mechanism with the PV panel. The behaviour of the voltage and the power profile curve is also analysed in both (*woc* and *wc*) cases. The plots show the improvement in maximum power and open circuit voltage after using a cooling mechanism with the PV panel being 6.73 W and 0.92 V as compared to that without cooling mechanism.

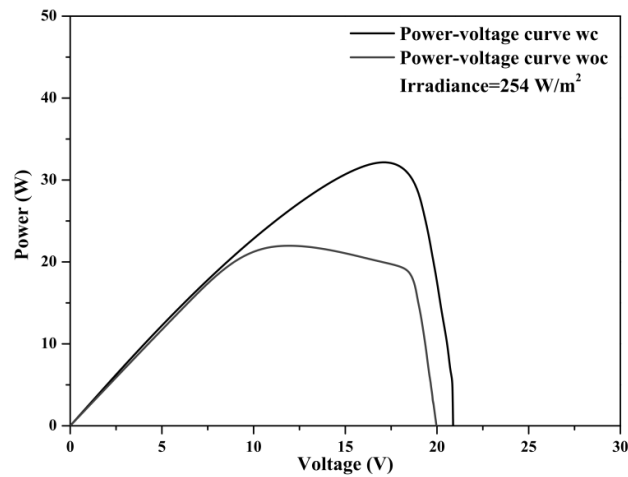

Fig. 19. Power-voltage curve at Irradiance = 254 W/m^2 in real time with cooling and without cooling

It is obtained from Fig. 19 that power profile and voltage profile are both improved about 11.41 W and 0.93 V when the PV panel refrigeration mechanism is connected as compared to that before connecting the proposed mechanism with the photovoltaic panel. PV panel's temperature decreases 40°C to 22° at solar Irradiance = 254 W/m^2 for cooling.

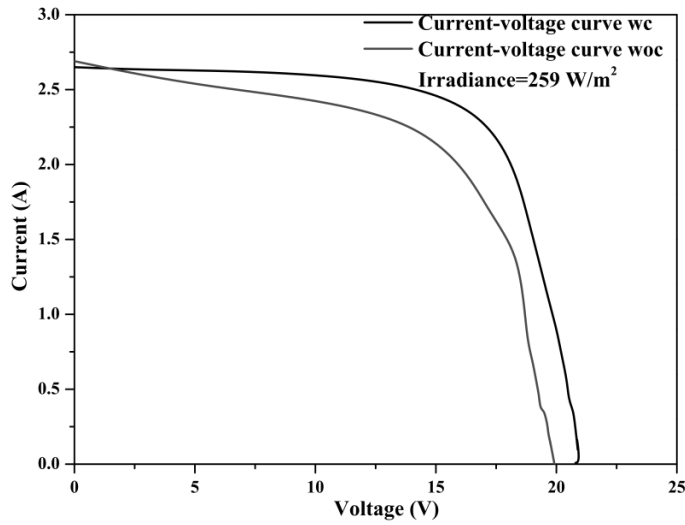

Fig. 20. Power-voltage curve at Irradiance = 259 W/m^2 in real time with cooling and without cooling

Improvement in power-voltage profile is observed from Fig. 20 during solar Irradiance = 259 W/m^2 after considering PV panel cooling mechanism during the variation of temperature of the panel. It is obtained from Fig. 20 that before applying the proposed cooling mechanism P_{max} is 29.38 W and V_{OC} is 19.92 V whereas after applying refrigeration scheme P_{max} is 37.26 W and V_{OC} is 20.83 V.

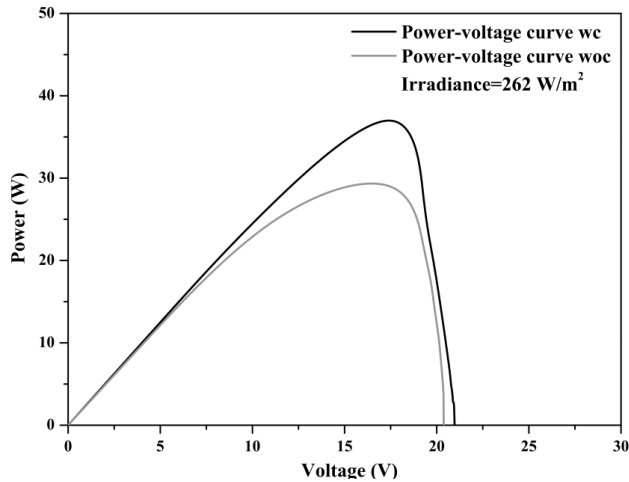

Fig. 21. Power-voltage curve at Irradiance = 262 W/m^2 in real time with cooling and without cooling.

Figure 21 shows the behaviour of power and voltage at Irradiance = 262 W/m^2 during a fault in PV panel due to temperature variation with and without PV panels refrigeration schemes. After using a PV panel refrigeration technique, temperature decreases from 32°C to 27° . The result shows that 8.26 W power and 0.23 V voltage are improved through the panel after considering PV panel refrigeration mechanism.

Improvement in open circuit voltage (V_{OC}), decrement in short circuit current (I_{SC}) due to cooling has been studied using both simulation and experiment for five sets of data. Enhanced V_{OC} and decreased I_{SC} when the proposed method is connected with the faulted PV panel are studied in both simulation and experiment. Simulation results are shown above and experimental analysis is shown below through the following graphs:

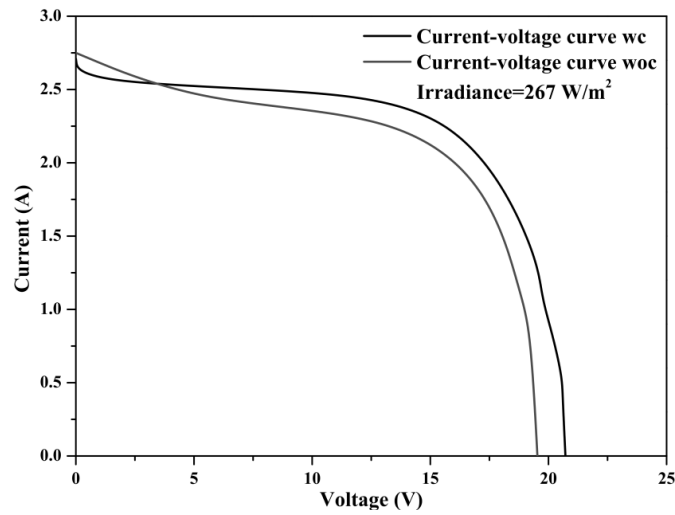

Fig. 22. Current-voltage curve at Irradiance = 267 W/m^2 in real time with cooling and without cooling.

From Fig. 22 it is found that after connecting proposed solar panel coolant procedure with the PV panel current deteriorates from 2.75 amp to 2.71 amp and voltage increases from 19.42 volt to 20.72 volt at irradiance = 267 W/m^2 .

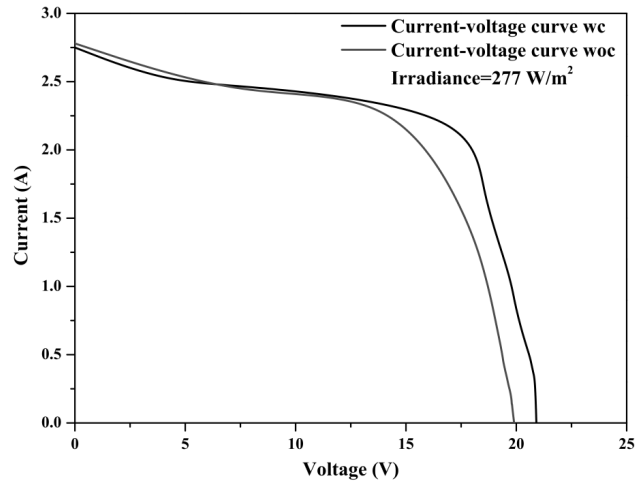

Fig. 23. Current-voltage curve at Irradiance = 277 W/m^2 in real time with cooling and without cooling

From Fig. 23 it is obtained that current flow through the PV panel is decreased from 2.78 amp to 2.75 amp and voltage profile will increase from 19.99 volt to 20.91 volt when the coolant mechanism is connected to the panel during the fault.

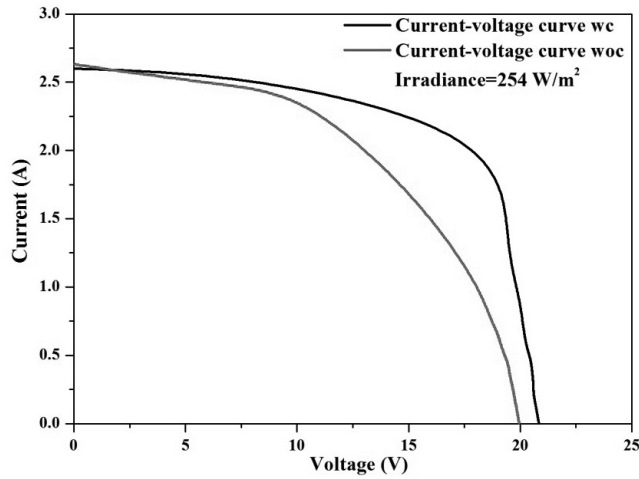

Fig. 24. Current-voltage curve at Irradiance = 254 W/m^2 in real time with cooling and without cooling

Figure 24 shows the I-V graph for irradiance = 254 W/m^2 in an experiment with and without the proposed coolant mechanism when PV panel temperature increases or decreases. V_{OC} increases about 0.93 volt and I_{SC} decreases about 0.03 amp due to the proposed PV panel coolant technique.

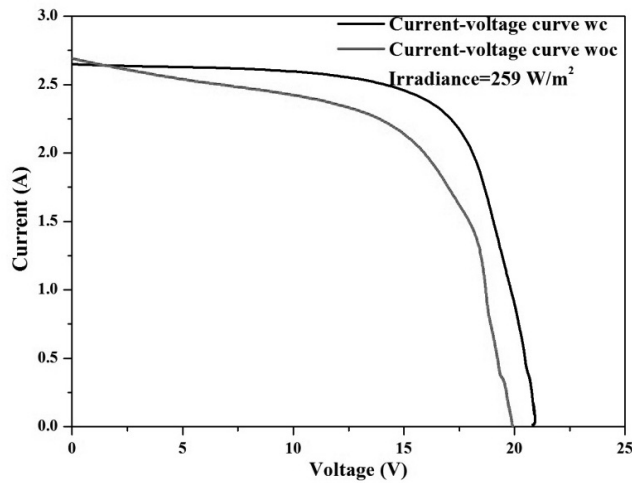

Fig. 25. Current-voltage curve at Irradiance = 259 W/m^2 in real time with cooling and without cooling

It is clear from Fig. 25 that there is considerable improvement in open circuit voltage, 0.91 volts, and decrement in short circuit current, 0.04 amp, when the proposed cooling methodology is considered with a photovoltaic panel.

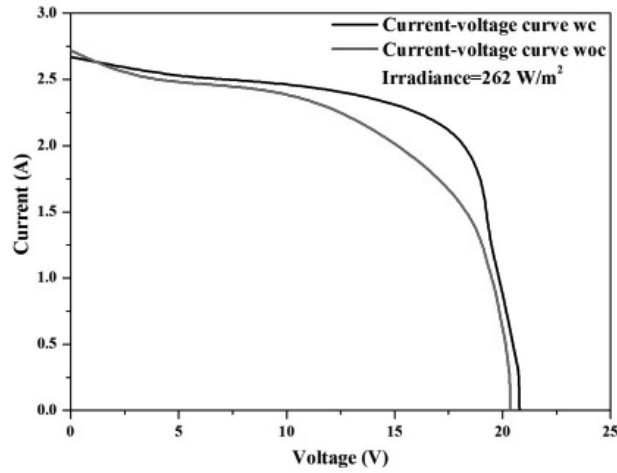

Fig. 26. Current-voltage curve at Irradiance = 262 W/m^2 in real time with cooling and without cooling.

Figure 26 shows the performance of current and voltage under temperature variation of PV panel with and without coolant technique. After considering the proposed refrigeration technique V_{OC} increases to 0.23 V and I_{SC} decreases to 0.05 A.

Improvement in power

Percentage of power improvement is the ratio of the difference between maximum power flows through the PV panel with cooling (wc) and without cooling (woc) during PV panel temperature variation to the power flows through the PV panel without cooling (woc).

Improvement in power for Irradiance = 267 W/m^2 (simulation)

$$P_{wc} = 38.68 \text{ W}, P_{woc} = 31.04 \text{ W}$$

$$P_{wc} - P_{woc} = (38.68 - 31.04) \text{ W} = 7.64 \text{ W}$$

$$\% \text{ Power Improvement} = \frac{P_{wc} - P_{woc}}{P_{woc}} \cdot 100 \% = 24.61\%$$

Improvement in power for Irradiance = 267 W/m^2 (experimental)

$$P_{wc} = 38.79 \text{ W}, P_{woc} = 30.5 \text{ W}$$

$$P_{wc} - P_{woc} = (38.79 - 30.5) \text{ W} = 8.29 \text{ W}$$

$$\% \text{ Power Improvement} = \frac{P_{wc} - P_{woc}}{P_{woc}} \cdot 100 \% = 27.18\%$$

Simulated and experimental results of a solar photovoltaic panel during temperature variation are tabulated in Table 2.

Table 2. Power improvement for Irradiance = 267 W/m² *wc* and *woc*

Output parameters	Simulation results		Experimental results	
	<i>wc</i>	<i>woc</i>	<i>wc</i>	<i>woc</i>
V_{oc} (volt)	19.69	19.03	20.72	19.42
P_{max} (watt)	38.68	31.04	38.79	30.5
% Power improvement	24.61		27.18	

Improvement in open circuit voltage is 0.66 V in simulation and 1.3 V in experiment, improvement in maximum power profile is 7.64 W in simulation and 8.29 W in experiment, and percentage of power improvement observed from Table 2 is 24.61% in simulation and 27.18% in experiment, when the PV panel refrigeration technique is connected with the PV panel.

Improvement in power for Irradiance = 277 W/m² (simulation)

$$P_{wc} = 39.65 \text{ W}, P_{woc} = 33.34 \text{ W}$$

$$P_{wc} - P_{woc} = (39.65 - 33.34) \text{ W} = 6.31 \text{ W}$$

$$\% \text{ Power Improvement} = \frac{P_{wc} - P_{woc}}{P_{woc}} \cdot 100 \% = 18.92\%$$

Improvement in power for Irradiance = 277 W/m² (experimental)

$$P_{wc} = 38.81 \text{ W}, P_{woc} = 32.08 \text{ W}$$

$$P_{wc} - P_{woc} = (38.81 - 32.08) \text{ W} = 6.73 \text{ W}$$

$$\% \text{ Power Improvement} = \frac{P_{wc} - P_{woc}}{P_{woc}} \cdot 100 \% = 20.79\%$$

Table 3. Power improvement for Irradiance = 277 W/m² *wc* and *woc*

Output parameters	Simulation results		Experimental results	
	<i>wc</i>	<i>woc</i>	<i>wc</i>	<i>woc</i>
V_{oc} (volt)	19.83	19.19	20.91	19.99
P_{max} (watt)	39.65	33.34	38.81	32.08
% Power improvement	18.92		20.97	

The open circuit voltage, percentage of power improvement, and maximum power also improved when the cooling is considered with the panel in real time experiment, and the simulation study is shown in Table 3. Enhancement of percentage of power in simulation as well as in experimental study is 18.92% and 20.97%, respectively.

Improvement in power for Irradiance = 254 W/m² (simulation)

$$P_{wc} = 36.92 \text{ W}, P_{woc} = 26.16 \text{ W}$$

$$P_{wc} - P_{woc} = (36.92 - 26.16) \text{ W} = 10.76 \text{ W}$$

$$\% \text{ Power Improvement} = \frac{P_{wc} - P_{woc}}{P_{woc}} \cdot 100 \% = 18.92\%$$

Improvement in power for Irradiance = 254 W/m² (experimental)

$$P_{wc} = 36.50 \text{ W}, P_{woc} = 25.09 \text{ W}$$

$$P_{wc} - P_{woc} = (36.50 - 25.09) \text{ W} = 11.41 \text{ W}$$

$$\% \text{ Power Improvement} = \frac{P_{wc} - P_{woc}}{P_{woc}} \cdot 100 \% = 45.47\%$$

Table 4. Power improvement for Irradiance = 254 W/m² wc and woc

Output parameters	Simulation results		Experimental results	
	wc	woc	wc	woc
V_{OC} (volt)	19.80	18.81	20.88	19.95
P_{max} (watt)	36.92	26.16	36.50	25.09
% Power improvement	41.13		45.47	

It is observed from table 4 that the power and voltage are increased after introducing the refrigeration technique with photovoltaic panel during panel's temperature variation at Irradiance = 254 W/m². Percentage of power improvement in the simulation is 41.13% and in an experiment, 45.47%.

Improvement in power for Irradiance = 259 W/m² (simulation)

$$P_{wc} = 37.63 \text{ W}, P_{woc} = 28.44 \text{ W}$$

$$P_{wc} - P_{woc} = (37.63 - 28.44) \text{ W} = 9.19 \text{ W}$$

$$\% \text{ Power Improvement} = \frac{P_{wc} - P_{woc}}{P_{woc}} \cdot 100 \% = 32.31\%$$

Improvement in power for Irradiance = 259 W/m² (experimental)

$$P_{wc} = 37.26 \text{ W}, P_{woc} = 29.38 \text{ W}$$

$$P_{wc} - P_{woc} = (37.26 - 29.38) \text{ W} = 7.88 \text{ W}$$

$$\% \text{ Power Improvement} = \frac{P_{wc} - P_{woc}}{P_{woc}} \cdot 100 \% = 26.82\%$$

Table 5. Power improvement for Irradiance = 259 W/m² *wc* and *woc*

Output parameters	Simulation results		Experimental results	
	<i>wc</i>	<i>woc</i>	<i>wc</i>	<i>woc</i>
V_{oc} (volt)	19.67	18.79	20.83	19.92
P_{max} (watt)	37.63	28.44	37.26	29.38
% Power improvement	32.31		26.82	

Table 5 shows that the voltage profile, maximum power profile of PV panel are increased after connecting proposed cooling technique with the PV panel during temperature variation at Irradiance = 259 W/m². From the above table it is also found that power improvement is 32.31% in a simulation study and 26.82% in an experimental study.

Improvement in power for Irradiance = 262 W/m² (simulation)

$$P_{wc} = 38.14 \text{ W}, P_{woc} = 28.47 \text{ W}$$

$$P_{wc} - P_{woc} = (38.14 - 28.47) \text{ W} = 9.67 \text{ W}$$

$$\% \text{ Power Improvement} = \frac{P_{wc} - P_{woc}}{P_{woc}} \cdot 100 \% = 33.96\%$$

Improvement in power for Irradiance = 262 W/m² (experimental)

$$P_{wc} = 37.79 \text{ W}, P_{woc} = 29.53 \text{ W}$$

$$P_{wc} - P_{woc} = (37.79 - 29.53) \text{ W} = 8.26 \text{ W}$$

$$\% \text{ Power Improvement} = \frac{P_{wc} - P_{woc}}{P_{woc}} \cdot 100 \% = 27.97\%$$

Table 6. Power improvement for Irradiance = 262 W/m² *wc* and *woc*

Output parameters	Simulation results		Experimental results	
	<i>wc</i>	<i>woc</i>	<i>wc</i>	<i>woc</i>
V_{oc} (volt)	19.47	19.26	20.61	20.38
P_{max} (watt)	38.14	28.47	37.79	29.53
% Power improvement	33.96		27.97	

Effects on solar photovoltaic panel during temperature variation without (*woc*) and with cooling (*wc*) are shown in Table 6.

Results of Table 6 show that the improvement in the percentage of power of PV panel after applying PV panel cooling mechanism is 33.96% in case of the simulation study and 27.97% in case of experimental study, respectively.

CONCLUSION

The effect of a fault in PV panel due to temperature variation and also an approach to mitigate this fault with very low cost setup are investigated in this paper. The study reveals the critical impact of the rise in temperature, which degrades the performance in terms of the output voltage and power and also disturbs the system stability. A deep analysis of the existing cooling systems was also done and this research work suggests a solution with very low cost design. As the coolant has to be having very good heat exchange property and also be of low-cost, water was chosen as a coolant. It was also kept in mind to design a system with less complexity and very easy to install. The cooling system cost should be very less comparative to the power generation cost from the PV system. So to execute the investigation, two 60 watt solar panels (Akshaya solar power) are considered with and without considering the cooling mechanism for analysis in simulation and as well as real time experiment. The behaviour of the P-V curve, I-V curve, open circuit voltage, maximum power, and percentage of improvement of power profile is analysed considering five sets of data at different solar irradiation at a different time in simulation and experiment. This paper basically focuses on PV panel's temperature variation and investigates its effect on a power-voltage characteristic curve, maximum power profile, and improvement of the percentage of power. It is observed in both environments (i.e., simulation and experiment) that, during temperature variation considering cooling mechanism with PV panel, power flows through the PV panel are increased and also there is an improvement in the voltage profile of the PV panel compared to that without cooling technique with the panel. The advantages of this paper are as follows: (i) temperature is brought down to a good extent, (ii) panel irradiance is not affected by the cooling system, (iii) no sophisticated equipment is required, (iv) regular water circulation is not required due to dripping, and (v) running and maintenance cost is very low.

APPENDIX S

Solar panel Type = Akshaya solar power

Wattage of each panel = 60W

Number of solar panel = 2

Reference solar irradiation = 1000 W/m^2

Electromagnetic Transient Design and Control/Power Systems Computer Aided Design = EMTDC / PSCAD

Standard Test Conditions = STC

ACKNOWLEDGMENT

The authors would like to thank The National Institute of Technology (NITA), India, for providing support for carrying out research & development work in this field.

REFERENCE

- Tian, H., Mancilla–David, F. & Ellis, K. 2013.** Determination of the optimal configuration for a photovoltaic array depending on the shading condition. *Solar Energy* 95: 1–12.
- Maghami, M.R., Hizam, H., Gomes, C., Radzi, M.A., Rezadad, M.I. & Hajjhorbani, S. 2016.** Power loss due to soiling on solar panel: A review. *Renewable and Sustainable Energy Reviews* 59: 1307–1316.
- Francis, E.D., Raghu, B. & Narayana, D.V. 2016.** Cooling Techniques for photovoltaic Module for Improving its Conversion efficiency: A Review. *International Journal of Engineering Inventions* 5(5): 69–73.
- Hasan, A., Alnoman, H. & Shah, A.H. 2016.** Energy Efficiency Enhancement of Photovoltaics by Phase Change Materials through Thermal Energy Recovery. *Energies* 9(10): 782.
- Teo, H.G., Lee, P.S. & Hawlader, M.N.A. 2012.** An active cooling system for photovoltaic modules. *Applied Energy* 90(1): 309–315.
- Makrides, G., Zinsser, B. & Phinikarides, A. 2012.** Temperature and thermal annealing effects on different photovoltaic technologies. *Renewable Energy* 43: 407–417.
- Hill, C.,** The Effects of Temperature on Solar Panel Power Production. *Demand Media*.
- Khan, F., Baek, S.H. & Kim, J.H. 2016.** Wide range temperature dependence of analytical photovoltaic cell parameters for silicon solar cells under high illumination conditions. *Applied Energy* 183: 715–724.
- Yong, C., Yiping, W. & Li, Z. 2015.** Performance analysis on a building-integrated solar heating and cooling panel. *Renewable Energy* 74: 627–632.
- Davidson, J.H., Christenson, R.L. & Christenson, J.A. 2014.** Solar heating and cooling. *Solar Energy* 104:1.
- Tobnaghi1, D.M., Madatov, R. & Naderi, D. 2013.** The Effect of Temperature on Electrical Parameters of Solar Cells. *International Journal of Advanced Research in Electrical, Electronics and Instrumentation Engineering* 2(12): 6404–6407.
- Xiao, C., Yu, X., Yang, D. & Que, D. 2014.** Impact of solar irradiance intensity and temperature on the performance of compensated crystalline silicon solar cells. *Solar Energy Materials & Solar Cells* 128: 427–434.
- Singh, P. & Ravindra, N.M. 2012.** Temperature dependence of solar cell performance—an analysis. *Solar Energy Materials & Solar Cells* 101: 36–45.
- Khan, F., Baek, S.H., Park, Y. & Kim, J.H. 2013.** Extraction of diode parameters of silicon solar cells under high illumination conditions. *Energy Conversion and Management* 76: 421–429.
- Byrne, P., Fournaison, L. & Delahaye, A. 2015.** A review on the coupling of cooling, desalination and solar photovoltaic systems. *Renewable and Sustainable Energy Reviews* 47: 703–717.
- Rustemli, S., Dincer, F. & Unal, E. 2013.** The analysis on sun tracking and cooling systems for photovoltaic panels. *Renewable and Sustainable Energy Reviews*, 22: 598–603.
- Bell, L. E. 2008.** Cooling, Heating, Generating Power and Recovering Waste Heat with Thermoelectric Systems. *Science* 321(5895):1457–1461.
- Ullah, K.R., Saidur, R. & Ping, H.W. 2013.** A review of solar thermal refrigeration and cooling methods. *Renewable and Sustainable Energy Reviews*, 24: 499–513.
- Ceylan, I., ErKaymaz, O. & Gedik, E., 2014.** The prediction of photo voltaic module temperature with artificial neural networks. *Case Studies in Thermal Engineering* 3: 11–20.
- Anand, S., Gupta, A. & Tyagi, S.K. 2015.** Solar cooling systems for climate change mitigation: A review. *Renewable and Sustainable Energy Reviews* 41: 143–161.

- Nunes, T.K., Vargas, J.V.C. & Ordonez, J.C. 2015.** Modeling, simulation and optimization of a vapor compression refrigeration system dynamic and steady state response. *Applied Energy* 158: 540–555.
- Hamdeh, N.H.A. & Al-Muhtaseb, M.A. 2010.** Optimization of solar adsorption refrigeration system using experimental and statistical techniques. *Energy Conversion and Management* 51(8): 1610–1615.
- Ghafoor, A. & Munir, A. 2015.** Worldwide overview of solar thermal cooling technologies. *Renewable and Sustainable Energy Reviews* 43:763–774.
- Zeyghami, M., Goswami, D.Y. & Stefanakos, E. 2015.** A review of solar thermo-mechanical refrigeration and cooling methods. *Renewable and Sustainable Energy Reviews* 51:1428–1445.
- Najafi, H. & Woodbury, K.A. 2013.** Optimization of a cooling system based on Peltier effect for photovoltaic cells. *Solar Energy* 91: 152–160.
- Askalany, A.A., Saha, B.B. & Kariya, K. 2012.** Hybrid adsorption cooling systems—An overview. *Renewable and Sustainable Energy Reviews* 16(8): 5787–5801.
- Moharram, K.A., Abd-Elhady, M.S. & Kandil, H.A. 2013.** Enhancing the performance of photovoltaic panels by water cooling. *Ain Shams Engineering Journal* 4(4): 869–877.
- Hu, Y., Gao, B. & Song, X. 2013.** Photovoltaic fault detection using a parameter based model. *Solar Energy* 96: 96–102.

SUBMITTED: 18/03/2017

REVISED : 02/06/2017

ACCEPTED : 24/07/2017

تحسين الطاقة في الألواح الكهروضوئية عند التفاوت في درجة الحرارة باستخدام آلية التبريد وتطبيقاتها

ساميمة أكثر، سابناديب ساها، بريانات داس

قسم الهندسة الكهربائية، المعهد الوطني للتكنولوجيا - أغراتالا، الهند

الخلاصة

تخضع خصائص طاقة الخرج في نظام الطاقة الشمسية الكهروضوئية (PV) إلى أشعة الشمس (G) ودرجة الحرارة (T) في البيئة المحيطة. ووفقاً لشروط الاختبار القياسية (STC)، فعندما تكون درجة حرارة اللوح الكهروضوئي 25 درجة مئوية، يوفر النظام الكهروضوئي أقصى قدر طاقة. ومع ارتفاع كل درجة مئوية في درجة الحرارة، تنخفض كفاءة طاقة الخرج بنسبة 1٪ تقريباً. ويقترح هذا البحث تحليل تأثير الخطأ بسبب التغير في درجة الحرارة على النظام الكهروضوئي ويقترح كذلك تقنية عملية عن تبريد الألواح الكهروضوئية لزيادة طاقة الخرج. تم تصميم نموذج باستخدام برنامج EMTDC / PSCAD مع مراعاة السيناريو الذي يحدث فيه تغير في درجة الحرارة ومن ثم تم تحليل الأداء، وتمت دراسة النموذج المحاكى عملياً. وتم اختيار لوحين، الأول (بدون تبريد) ويعتبر كمرجع للمقارنة والثاني (مع التبريد) لدراسة تعزي أداء اللوح الكهروضوئي. وتم التحكم في درجة حرارة اللوح الكهروضوئي بواسطة مبرد المياه باستخدام كيس الجوت المنقوع في الماء على الجانب الخلفي من اللوح. وتمت دراسة التغيرات في منحنى القدرة - الفولطية (P-V)، ومنحنى جهد - التيار (I-V)، وملف الجهد الكهربائي للدائرة المفتوحة، وتيار الدائرة القصيرة، والقدرة القصوى والنسبة المئوية للفق الطاقة بسبب تأثير الخطأ أثناء تغير درجة الحرارة على اللوح الكهروضوئي بدون آلية التبريد وتحسين الطاقة بسبب التبريد باستخدام كل من المحاكاة والتجارب على خمس مجموعات من البيانات. تم تثبيت الأجهزة التجريبية على سطح مبنى رقم G+6 التابع للمعهد الوطني للتكنولوجيا بأغراتالا للتحقق من صحة المخطط المقترح.