

Development and Evaluation of Dust Cleaning System for a Solar PV Panel

Abhishek Kumar Tripathi*, Mangalpady Aruna**, Shashwati Ray***, N R N V Gowripathi Rao****, S. Vamshi Krishna***** and Durgesh Nandan*****

*Department of Mining Engineering, Aditya Engineering College, Surampalem, A. P., India.

**Department of Mining Engineering, National Institute of Technology Karnataka, Surathkal, India

***Department of Electrical Engineering, Bhilai Institute of Technology, Durg, India

****Department of Agricultural Engineering, Aditya Engineering College, Surampalem, A.P, India

*****Department of Electronics and Communication Engineering, Ravindra College of Engineering for Women, Kurnool, A.P., India

*****Account Manager, Accendere Knowledge Management Services Pvt Ltd., CL Educate Ltd., New Delhi, India

Corresponding Author: abhishekkumar@aec.edu.in

ABSTRACT

The most promising application of solar energy is the conversion of solar energy into electrical energy by using solar photovoltaic (PV) panel. The performance of solar based PV panel is definitely influenced by the amount of solar radiation, which are reaching on the panel surface. Since the solar PV panels are operating in open atmosphere dust particles get deposited on their surfaces and most of the times they have to work in this condition. These deposited dust particles create a layer of dust particles over the panel surface which prevents the 100% penetration of solar radiation into the panel surface. Therefore, proper cleaning of the panel surface becomes very necessary. In order to improve the performance of the PV panel an automatic microcontroller driven dust cleaning technique is developed which is capable of removing the accumulated dust particles from the PV panel surface. Moreover, an experimental study has been performed to analyse the efficiency of this developed technique. The developed cleaning system showed an improvement of 27.98% in the output power of PV panel when compared to the dusty panel.

Keywords: Solar energy; Photovoltaic panel; Dust; Automatic cleaning.

INTRODUCTION

Human sustainability and development of any nation highly depends upon three factors that are water, power and health. Excluding the other two factors the remaining third factor, i.e., power is most significant for every individual and it provide a major contribution in the development of any nations. The unavailability or shortage of power affect the industrial and economic growth of the country. But, due to the rapid growth in the population and fast depletion of fossil reserves an alarming signal can be observed in the power storage scheme. Thus, it is necessary to plan an alternative way so that the issue of power shortage can be minimised (García and Balenzategui, 2004; Hammond et al., 1997). In this regard, the application of renewable energy can be treated as the primary form of electrical power generation. The practice of encouraging renewable energy as the primary form of electrical power generation is not only sponsoring the green energy atmosphere but also sufficing the energy requirement of the world energy traders (Jager-Waldau, 2011). Also, the usage of renewable energy reduces the carbon emission which helps in mitigating the greenhouse effects and promoting the clean energy (Arango et al., 2018).

The available renewable energy sources are hydro, geothermal, biomass, wind and solar (sunlight based). Out of these sources, solar energy is getting increasingly more consideration in the last two decades in view of its enormous advantages, such as ease of accessibility of raw material (because sun rays are available in the infinite amount) of the sun rays, no discharge of any poisons gasses, can be utilised in remote territories, do not produce noise issue, simple installation and fillip by government. Also, the energy originating from the sun is very huge and is an infrangible energy

source. Therefore, the usage of sun-based energy in the electricity generation can be considered as the best alternative (Mani and Pillai, 2010). In sun-based energy system the photovoltaic (PV) technology is used to generate electrical energy from the sunlight and the material which is used in this effect is called photovoltaic (PV) cell (Mekhilef et al., 2011). Since, the PV device is made up of silicon type semiconductors which is capable of generating the free pairs of electron-hole when any amount of sunlight falls on its surface. Due to the generation of this free electron-hole pairs a kind of photo current starts flowing in the outer circuit of semiconductor and this is the main cause of the electricity generation

By and large, the PV panel works in an open-air, where it encounters a critical variation during its exposure by environmental parameters (Jiang et al., 2011). Therefore, in the outside regime the efficacy of a PV panel system is mainly influenced on by the variation in the ambient parameters. In general, the performance of PV panel is highly affected by two line of reasoning, firstly by its design (internal design) and secondly by its surrounding working parameters (external entity). The internal design parameters that affect the PV panel operation are surface temperature, panel setup, tilt angle, erosion and breaking of cells, delamination of the cells and so on and so forth. Likewise, the external working parameters are dust, humidity, surrounding air temperature, wind speed, sun radiation and the amount of shading over the panel surface (Chaichan and Kazem, 2020; Gholami et al., 2020). Among all the external design parameters, dust can be assumed to a major contributor in diminishing the PV panel performance, while other external parameters play significant role in gathering and spreading the dust over the panel surface (Darwish et al., 2018). Hence, the need of studying the panel performance under dusty condition is becoming very essential in order to extract maximum efficacy of the panel. In this context, the present research work highlights the impact of the dust on PV panel efficacy and also the need of proper and efficient dust cleaning technique which can improve the performance of solar PV panel. Therefore, keeping this point in mind an automatic dust cleaning system is developed which is explained elaborately in this paper. Also, its necessity is demonstrated with the discussion on the results obtained from the experimental studies conducted.

ROLE OF DUST ON PV PANEL PERFORMANCE

The most influencing environmental entity that affects the performance of PV panel is the presence of dust particles in an ambient cloud. Here, when the PV panel exposes in open air then the air dust gets settled in its surface and make its surface dusty. However, with ever increasing industrialisation and constructional activities the dust generation in the environment is aggravating (Adinoyi and Said, 2013; Klugmann-Radziemska, 2015). Further, the gathering of dust over the power surface of PV panel surface sufficiently restricts the quantity of sunlight reaching the panel surface (Kaldellis and Kapsali, 2011). The restriction of sunlight reaching the panel surface depends on the size, density and type of the deposited dust particles (Darwish et al., 2015). Thus, cladding of PV panel surface with dust significantly reduces its output efficiency (Al-Hasan and Ghoneim, 2005; Sulaiman et al., 2014).

One of the studies in relation to the dust depositions reported that power generation capacity and PV panel efficiency reduces up to 92.11% and 89%, respectively owing to the dusty panel (Rajput and Sudhakar, 2013). One more study in connection with turbidity of the panel surface found the reduction of 4.41%, 4.79% and 7.34% in short circuit currents of three different type of PV panel namely, monocrystalline, multi crystalline and amorphous respectively (Chegaar and Mialhe, 2008). A work carried out on the dethronement of the panel glass showed that its transmittance reduces from 12.38% to 52.4% for the deposition of 4.48 g/m² to 15.84 g/m² of dust (Elminir et al., 2006). One more study reported the reduction in panel efficiency of 10%, 16% and 20% due to respective deposition of 12.5 g/m², 25 g/m² and 37.5 g/m² of dust density over the panel surface (El-Shobokshy and Hussein, 1993). Another study conducted on soiling of grid connected PV panel system in Atacama showed 7% annual energy loss. Also, the combination of dust deposition and irregular rainfall reduces the annual energy with peak loss of 39% (Cordero et al., 2018).

A study carried out by Kaldellis and Kapsali on the deposition of different type of dust namely, red soil, lime stone and ash showed the energy losses of PV module of 19%, 10% and 6% respectively (Kaldellis and Kapsali, 2011). Similarly, one more study reported that the ash dust deposition showed a maximum of 4.7 V of PV output voltage (Khatib et al., 2013). Another study conducted in the tropical region confirmed that the soiling over the panel surface

deteriorates the output of the panel with rise in its surface temperature (Andrea et al., 2019). Thus, in this context a study of the techno-economic impacts of soiling on power loss of PV panel was conducted where it was confirmed that the soiling effect can reduce the current global solar power by at least 3% to 4% (Ilse et al., 2019). The above literature undebatable indicated the possible role of cleaning operations on the dusty panel surface. Therefore, different PV panel surface cleaning techniques are discussed in the next section.

PV PANEL SURFACE CLEANING TECHNIQUES

The existing literature study shows that the soiling of the panel surface severely deteriorates its efficiency. Therefore, to recover the efficacy of the PV panel there is a necessity to design a dust cleaning system that can clean the dust from the panel surface, so as it can be recovered the probable loss of energy. Some dust cleaning techniques are natural cleaning, manual cleaning with water, automatic cleaning and electrostatic cleaning system (Sayyah et al., 2014). These cleaning techniques is discussed, in detail, in the below sections.

One of the most popular and simple cleaning techniques is the natural cleaning process or system i.e., "rainfall". The performance and efficiency of the panel is improved by rainfall as accumulated dust particles from the surface of the panel are removed due to drops of the rain water. The study conducted in the higher latitude zones showed significant improvements in the panel performance was reported due to natural rainfall (Haerberlin and Graf, 1998). But this cleaning system will be very ineffective where the rainfall is intermittent, for example in semi-arid and desert areas where the rainfall occasionally happens. Moreover, low rainfall in the dusty environment followed by dusty wind increases the accumulation of dust on the panel surface, subsequently reducing its performance. Hence, the natural cleaning system of the panel surface is not reliable and not efficient in low rainfall areas.

Often in small scale installations, water blended with cleanser followed by wiper action through soft cloth is the most widely recognized practice for eliminating the soiling effect from the panel surface (Mohamed and Hasan, 2012; Zorrilla-Casanova et al., 2013). However, for large scale installation of PV plants, pressurised water jet, brushing cleaning has been reported in many investigations (Kimber, 2007). It is a better practice than the natural rainfall cleaning system since its cleaning frequency and efficiency is higher than the latter. One study reported that the manual cleaning with water and brush arrangement increased the efficacy of the PV plant by 6.9% (Pavan et al., 2011). But this cleaning system is quite expensive as it includes the cost of labour, water and also requires trained personnel. Moreover, this cleaning system is not applicable where the scarcity of water is the prime concern.

An automatic cleaning system is very effective in highly dusty environment. This system uses computer controlled mechanical devices to clean the panel surface. This cleaning system is more efficient and reliable as it is devoid of the extra labour and water cost. A study conducted by Tejwani and Solanki demonstrated an increase in the output of the panel by 15% compared to the panel which is not having integrated automatic cleaning system (Tejwani and Solanki, 2010). The replacement of water and chemical cleaning by an automatic cleaning system is the best alternative solution as it does not use water (which needs to be saved) and chemicals (which may be detrimental). The transmittance of the glass of the panel may be affected or in the worst situation may lead to damage of the panel surface by the usage of chemical particles over the upper surface of the panel.

Another method of cleaning the dust surface from the panel is the "electrostatic dust cleaning system". In this method, a set of sinusoidal electrodes is used on the panel surface which is implanted on the transparent dielectric film. Whenever the panel surface is charged, it attracts the opposite charge and repels the similar charge. This cleaning system requires high electric field for a short duration to generate a standing wave by an alternating electric field. This procedure of removing the soiling effect from the panel requires no mobile part and water resource. Further, this type of cleaning system was used in some space craft mission where it was observed that the high amount of pulse power is only sufficient to remove the dust. However, this method of cleaning is still in the developmental stage (Kawamoto and Shibata, 2015; Mazumder et al., 2013).

DEVELOPMENT OF AUTOMATIC CLEANING SYSTEM

The solar PV panel placed in the outside environment converts the sunlight into electricity. During this process, the panel performance gets affected by dust deposition as discussed in the earlier section. Hence, to improve the panel performance in dusty environment, an automatic cleaning technique was developed and the experiments were carried out to analyse its efficiency.

Experimental Set-up

The block diagram of the developed automatic dust cleaning technique is depicted in Figure 1. This technique consists of a microcontroller, a DC motor driver circuit and a wiper arrangement section. As shown in Figure 1, the DC motor gets activation signal from the microcontroller and facilitates the wiper to move up and down on the panel surface to clean the gathered dust. The microcontroller is programmed based on the cleaning time required. Once the required time matches with the real time clock (which is shown in Figure 2), the microcontroller activates the motor-wiper section and the wiper movement starts automatically thus cleaning the PV panel surface. A 10W polycrystalline PV panel was employed in the present cleaning technique and its technical detail is tabulated in Table 1. Further, Atmega 2560 Arduino was used as the microcontroller in the present work and its technical specification is provided in the Table 2. Figure 2 presents the aforementioned cleaning technique schematic circuit diagram.

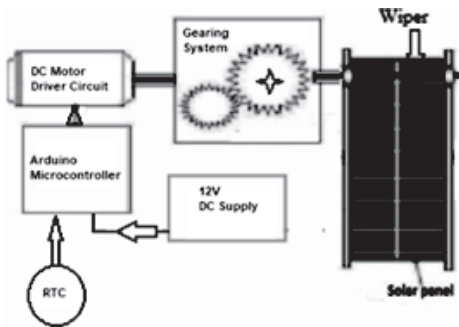

Figure 1. Block diagram of PV panel surface cleaning system

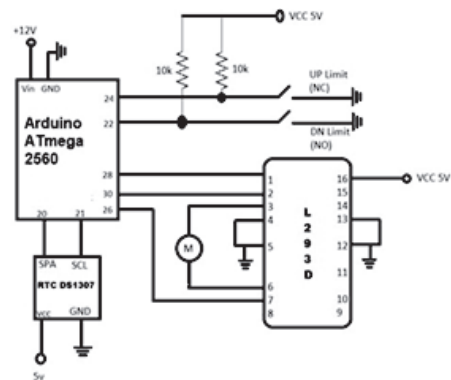

Figure 2. Schematic circuit diagram of cleaning technique

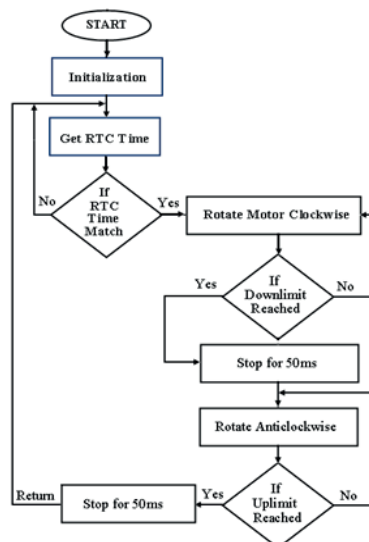

Figure 3. Flow chart of cleaning technique

Table 1. Specifications (technical) of 10W PV panel.

Parameter	Ratings
Open circuit voltage (volt)	21.50
Short circuit current (amp)	0.59
Maximum voltage (volt)	17.00
Maximum current (amp)	0.56
Maximum Power (watt)	10.00
Fill Factor	0.75
Dimensions L x W x H	285 × 350 × 22 mm

Different Components of Cleaning Set-up

The various components were used in the development of dust cleaning technique. The detail description of various components which are used in the experimental set-up are given in the following sections

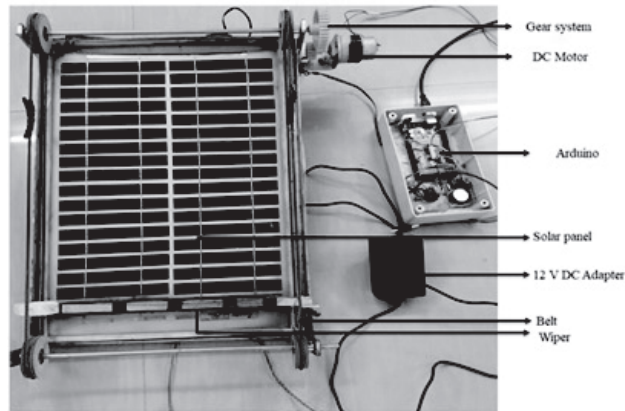
**Figure 4.** Photograph of PV panel surface cleaning set-up**Table 2.** Specifications (technical) of Atmega 2560 Arduino

Parameter	Specifications
Open circuit voltage	5 volt
Input Voltage (recommended)	7-12volt
Minimum Input Voltage	6 volt
Maximum Input Voltage	20 volt

Number of digital I/O Pins	54
Number of analog Input Pins	16
DC Current per I/O Pin	40 mA
Flash Memory	256 KB
SRAM	8 KB
EEPROM	4 KB
Clock Speed	16 MHz

Figure 3. illustrates the flow chart of cleaning system and Figure 4 gives photographic view of the entire cleaning system set-up.

Solar PV panel

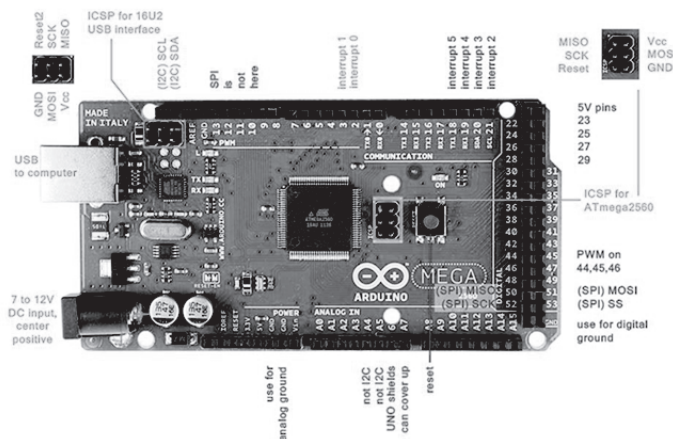

In this study a 10W solar PV panel was used and its technical specifications are presented in Table 1.

Figure 5. Pin diagram of Arduino Atmega 2560

Arduino microcontroller (Atmega 2560)

Arduino was used as a microcontroller in this study, whose function was to store the desired programme and to give the output (O/P) in the form of discrete or digital signal to the motor driver circuit for controlling the rotation of the motor. The internal structure with pin diagram of Atmega 2560 arduino is shown in Figure 5. It has 54 digital input/output pins out of which 15 pins can be used as PWM outputs, 16 pins as analog inputs and 4 pins as hardware serial ports. It is also provided with a 16 MHz crystal oscillator, a USB connection, a power jack, an in-circuit serial programming (ICSP) header and a reset button. The technical specifications of arduino (Atmega 2560) are provided in Table 2.

Motor driver circuit

The integrated circuit (Model: L293D) was used as a bidirectional motor driver circuit in this set-up. It operates the motor in both the directions, i.e., clockwise and anticlockwise depending upon the input signal received from the arduino (Atmega 2560) microcontroller. The integrated circuit (IC) and its pin diagram are shown in Figure 6 and Figure 7 respectively. It has 16 pins out of which pin number 1 and 9 are the enable pins. So, when pin number 1 receives 'high' signal/command then all the pins on left side get activated. Similarly, when pin number 9 receives 'high' signal/command then all the pins on right side get activated. In Figure 7, pin numbers 2, 7, 15 and 10 are the input pins, pin numbers 3, 6, 14 and 11 are the output pins and pin numbers 4, 5, 13 and 12 are the ground pins. The pin numbers 8 and 16 are the power supply pins, which have the voltage limiting between 4.5V - 36V.

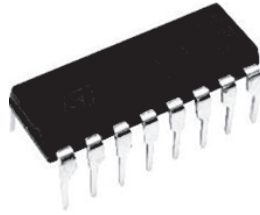

Figure 6. IC L293D motor driver

In Figure 7, the input pins on the left side of IC regulate the motor action which is connected on the left side. Similarly, the operation of the motor which is connected on the right side of the IC is controlled by the pins on the right side. The rotation of the motor depends on the inputs provided across the input pins as zero and one logic. Using the input pins numbered 2 and 7, the motor was connected with the IC to the left side in this experimental set-up.

DC motor

Direct current motor is an actuator that is capable of converting the energy from one form into another, i.e., electrical into mechanical energy, which was used to move the wiper up and down on the panel surface in such a way that the wiper cleaned the accumulated dust from the panel surface. A photographic view of DC gear motor is illustrated in Figure 8 and its technical specifications are given in Table 3. The motor was operated at 5V and 70mA load current, and the power consumed was calculated as 0.35W.

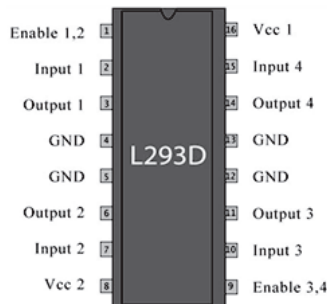

Figure 7. Pin diagram of IC L293D



Figure 8. Dc Gear Motor

Table 3. Technical specifications of the DC motor

Parameter	Rating
Voltage limit (volt)	12.00
Rotation speed (RPM)	10.00
Shaft diameter (mm)	6.00
Weight (gm)	125.00
Torque (Kg-cm)	12.00
No load current (mA)	60.00
Full load current (mA)	300.00
Flash Memory	256 KB

Real Time Clock (RTC)

It is an electronic device which was used to keep an accurate time to track the current time of programme provider, i.e., the personal computer. The photographic view of a RTC is shown in Figure 9.

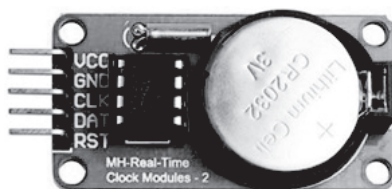
**Figure 9.** Real Time Clock

DC power supply

The recommended input voltage for the arduino Atmega 2560 was ranging between 7V-12V (refer Table 2). Therefore, a 12V DC source of power was used to supply the desired power to the arduino circuit to maintain the required input voltage limit as can be seen in Figure 4.

Wiper

To clean the accumulated dust from the panel, surface a dry sponge wiper was used. The advantage of dry sponge is that it does not absorb dust and water particles. The photographic view of the wiper piece used in the experimental set-up can be seen by Figure

Limit switch

It is an electromechanical device activated by the contact of the wiper sliding over the panel surface. Two such devices are located on both the ends of the panel. These devices got actuated when they came in contact with the wiper and thus could send signals to the microcontroller circuit so as to reverse the direction of the movement of the wiper. The photograph of limit switch is shown in Figure 10.



Figure 10. Limit switch

Belt and Wheels

Two ends to end belts were mounted along the length of the panel which were supported by two sets of wheels as can be seen in Figure 4. These wheels were driven by the motor. These belts carrying the wiper facilitated the movement of the wiper over the panel surface.

EXPERIMENTAL STUDY

This study was carried out using the developed experimental set-up with a 10W PV panel having upper surface area of 0.09975 m². The panel was placed under an artificial solar radiation of 442 W/m². The electrical output power of the panel was obtained by measuring its output current and voltage under the application of 442 W/m² solar radiation. Thereafter, 3 gm of dust was spread over the panel surface with the help of a strainer and its output electrical quantities were measured. Next, the panel surface was cleaned once using the developed automatic cleaning system (i.e., from one side to other side and back) and again its electrical parameters were measured. Thus, the electrical parameters of the panel were measured under three-different panel surface conditions, viz., clean surface, dusty surface and cleaned surface. The measured electrical parameters under three different panel surface conditions are given in Table 4. From the measured electrical parameters its electrical responses, such as ISC, VOC and P_{MAX} were calculated and tabulated as indicated in Table 4.

Table 2. Computed electrical parameters.

Nature of Panel Surface	Clean Panel	Dusty Panel	Cleaned Panel
Short circuit Current I _{SC} (A)	0.25	0.16 (36% reduction w.r.t clean panel)	0.20 (20% reduction w.r.t clean panel/ 25.00% improvement w.r.t dusty panel)
Open circuit voltage V _{OC} (V)	18.5	17.8 (3.78% reduction w.r.t clean panel)	18.3 (1.80% reduction w.r.t clean panel/ 2.80% improvement w.r.t dusty panel)
Maximum power output P _{MAX} (W)	3.116	1.794 (42.42% reduction w.r.t clean panel)	2.296 (26.31% reduction w.r.t clean panel/ 27.98% improvement w.r.t dusty panel)

Based on the obtained output values of the panel, the current-voltage and power-voltage characteristics of the panel were plotted as shown in Figure 11 and Figure 12. The plotted characteristic curves shown in Figure 11 and Figure 12 clearly indicate that the proposed cleaning system shows an improvement in the panel performance. The increment in the ISC, VOC and PM AX of a cleaned panel are respectively, 25.00%, 2.80% and 27.98% with respect to the dusty panel. These obtained results show quite an appreciable amount of increment in the output of the PV panel. Moreover, the developed cleaning system consumes very less power of 0.35 W which is the constant power required for the cleaning system irrespective of the solar radiation and panel size. On the contrary, the developed cleaning system gives an appreciable amount of power increments with respect to the dusty panel. Hence, the developed cleaning technique helps the solar PV industry to recover its lost generated power under any dusty environment.

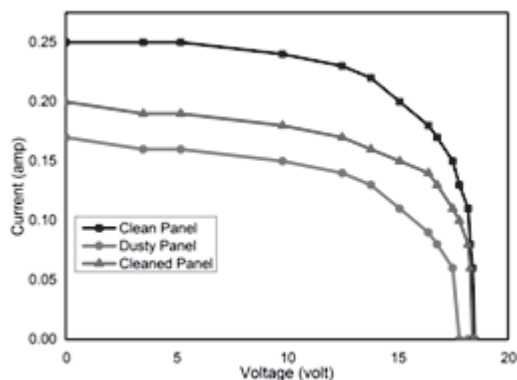

Figure 11. I-V characteristics curves for three different panel surface conditions

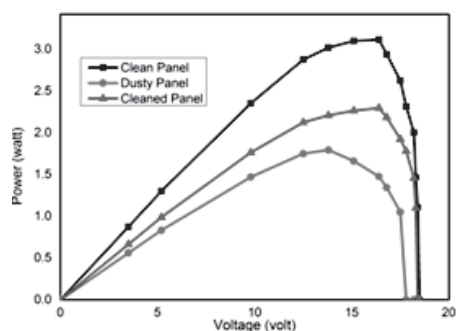

Figure 12. P-V characteristic curves for three different panel surface condition

CONCLUSION

Air pollution not only affects the human health, but also disturbs their day-to-day activities. Airborne dust is a major concern in industrial zone which is a direct threat to the environment. It is a well-known fact that solar PV panel work on the principle of photovoltaic effect, i.e., electricity is generated when photons (from direct irradiance) fall onto it. Hence, any form of obstacle hindering the sunlight will certainly affect the output of solar PV panel. Therefore, to improve the performance of solar photovoltaic panel in dusty environment, a proper and systematic cleaning of the panel surface is essential which would remove the accumulated dust. To demonstrate this issue, an automatic dust cleaning system was developed and its performance was studied in the laboratory. The developed cleaning system for PV panel surface showed an increment of 25.00% in short circuit current, 2.80% in open circuit voltage and 27.98% in maximum power output when compared to a dusty panel. As this study was conducted in the laboratory scale, the developed cleaning system could not be assessed for its economic viability.

REFERENCES

- Adinoyi, M.J., Said, S.A., 2013.** Effect of dust accumulation on the power outputs of solar photovoltaic modules. *Renewable energy* 60, 633–636.
- Al-Hasan, A.Y., Ghoneim, A.A., 2005.** A new correlation between photovoltaic panel's efficiency and amount of sand dust accumulated on their surface. *International Journal of Sustainable Energy* 24, 187–197. <https://doi.org/10.1080/14786450500291834>
- Andrea, Y., Pogrebnaya, T., Kichonge, B., 2019.** Effect of Industrial Dust Deposition on Photovoltaic Module Performance: Experimental Measurements in the Tropical Region. *International Journal of Photoenergy* 2019. <https://doi.org/10.1155/2019/1892148>

- Arango, D., Urrego, R., Rivera, S., 2018.** Robust loss coefficients: application to power systems with solar and wind energy. *International Journal of Power and Energy Conversion* 9, 351–383.
- Chaichan, M.T., Kazem, H.A., 2020.** Experimental evaluation of dust composition impact on photovoltaic performance in Iraq. *Energy Sources, Part A: Recovery, Utilization, and Environmental Effects* 1–22. <https://doi.org/10.1080/15567036.2020.1746444>
- Chegaar, M., Mialhe, P., 2008.** Effect of atmospheric parameters on the silicon solar cells performance. *Journal of Electron Devices* 6. <https://doi:10.1.1.665.2318&rep=rep1&typdf>
- Cordero, R.R., Damiani, A., Laroze, D., MacDonell, S., Jorquera, J., Sepúlveda, E., Feron, S., Llanillo, P., Labbe, F., Carrasco, J., 2018.** Effects of soiling on photovoltaic (PV) modules in the Atacama Desert. *Scientific reports* 8, 1–14.
- Darwish, Z.A., Kazem, H.A., Sopian, K., Alghoul, M.A., Alawadhi, H., 2018.** Experimental investigation of dust pollutants and the impact of environmental parameters on PV performance: an experimental study. *Environment, development and sustainability* 20, 155–174. <https://doi.org/10.1007/s10668-016-9875-7>
- Darwish, Z.A., Kazem, H.A., Sopian, K., Al-Goul, M.A., Alawadhi, H., 2015.** Effect of dust pollutant type on photovoltaic performance. *Renewable and Sustainable Energy Reviews* 41, 735–744. <https://doi.org/10.1016/j.rser.2014.08.068>
- Elminir, H.K., Ghitas, A.E., Hamid, R.H., El-Hussainy, F., Beheary, M.M., Abdel-Moneim, K.M., 2006.** Effect of dust on the transparent cover of solar collectors. *Energy conversion and management* 47, 3192–3203. <https://doi.org/10.1016/j.enconman.2006.02.014>
- El-Shobokshy, M.S., Hussein, F.M., 1993.** Degradation of photovoltaic cell performance due to dust deposition on to its surface. *Renewable Energy* 3, 585–590.
- García, M.A., Balenzategui, J.L., 2004.** Estimation of photovoltaic module yearly temperature and performance based on nominal operation cell temperature calculations. *Renewable energy* 29, 1997–2010. <https://doi.org/10.1016/j.renene.2004.03.010>
- Gholami, A., Ameri, M., Zandi, M., Ghoachani, R.G., Eslami, S., Pierfederici, S., 2020.** Photovoltaic Potential Assessment and Dust Impacts on Photovoltaic Systems in Iran. *IEEE Journal of Photovoltaics* 10, 824–837. <https://doi.org/10.1109/JPHOTOV.2020.2978851>
- Haeberlin, H., Graf, J.D., 1998.** Gradual reduction of PV generator yield due to pollution. *Power [W] 1200, 1400.* http://www.pv-test.ch/Dokumente/Publikationen/058_Pollpv2.pdf
- Hammond, R., Srinivasan, D., Harris, A., Whitfield, K., Wohlgemuth, J., 1997.** Effects of soiling on PV module and radiometer performance, in: *Photovoltaic Specialists Conference, 1997., Conference Record of the Twenty-Sixth IEEE.* IEEE, pp. 1121–1124.
- Ilse, K., Micheli, L., Figgis, B.W., Lange, K., Daßler, D., Hanifi, H., Wolfertstetter, F., Naumann, V., Hagedorf, C., Gottschalg, R., 2019.** Techno-economic assessment of soiling losses and mitigation strategies for solar power generation. *Joule.*
- Jager-Waldau, A., 2011.** Progress in chalcopyrite compound semiconductor research for photovoltaic applications and transfer of results into actual solar cell production. *Solar Energy Materials and Solar Cells* 95, 1509–1517.
- Jiang, H., Lu, L., Sun, K., 2011.** Experimental investigation of the impact of airborne dust deposition on the performance of solar photovoltaic (PV) modules. *Atmospheric Environment* 45, 4299–4304. <https://doi.org/10.1016/j.atmosenv.2011.04.084>

- Kaldellis, J.K., Kapsali, M., 2011.** Simulating the dust effect on the energy performance of photovoltaic generators based on experimental measurements. *Energy* 36, 5154–5161.
- Kawamoto, H., Shibata, T., 2015.** Electrostatic cleaning system for removal of sand from solar panels. *Journal of Electrostatics* 73, 65–70. <https://doi.org/10.1016/j.elstat.2014.10.011>
- Khatib, T., Kazem, H., Sopian, K., Buttinger, F., Elmenreich, W., Albusaidi, A.S., 2013.** Effect of dust deposition on the performance of multi-crystalline photovoltaic modules based on experimental measurements. *International Journal of Renewable Energy Research (IJRER)* 3, 850–853.
- Kimber, A., 2007.** The effect of soiling on photovoltaic systems located in arid climates, in: *Proceedings 22nd European Photovoltaic Solar Energy Conference*.
- Klugmann-Radziemska, E., 2015.** Degradation of electrical performance of a crystalline photovoltaic module due to dust deposition in northern Poland. *Renewable Energy* 78, 418–426.
- Mani, M., Pillai, R., 2010.** Impact of dust on solar photovoltaic (PV) performance: Research status, challenges and recommendations. *Renewable and Sustainable Energy Reviews* 14, 3124–3131.
- Mazumder, M., Horenstein, M.N., Stark, J.W., Girouard, P., Sumner, R., Henderson, B., Sadler, O., Hidetaka, I., Biris, A.S., Sharma, R., 2013.** Characterization of electrodynamic screen performance for dust removal from solar panels and solar hydrogen generators. *IEEE Transactions on Industry Applications* 49, 1793–1800.
- Mekhilef, S., Saidur, R., Safari, A., 2011.** A review on solar energy use in industries. *Renewable and Sustainable Energy Reviews* 15, 1777–1790.
- Mohamed, A.O., Hasan, A., 2012.** Effect of dust accumulation on performance of photovoltaic solar modules in Sahara environment. *Journal of Basic and applied scientific Research* 2, 11030–11036.
- Pavan, A.M., Mellit, A., De Pieri, D., 2011.** The effect of soiling on energy production for large-scale photovoltaic plants. *Solar energy* 85, 1128–1136.
- Rajput, D.S., Sudhakar, K., 2013.** Effect of dust on the performance of solar PV panel. *Int J ChemTech Res* 5, 1083–6.
- Sayyah, A., Horenstein, M.N., Mazumder, M.K., 2014.** Energy yield loss caused by dust deposition on photovoltaic panels. *Solar Energy* 107, 576–604.
- Sulaiman, S.A., Singh, A.K., Mokhtar, M.M.M., Bou-Rabee, M.A., 2014.** Influence of dirt accumulation on performance of PV panels. *Energy Procedia* 50, 50–56.
- Tejwani, R., Solanki, C.S., 2010.** 360 sun tracking with automated cleaning system for solar PV modules, in: *Photovoltaic Specialists Conference (PVSC), 2010 35th IEEE*. IEEE, pp. 002895–002898.
- Zorrilla-Casanova, J., Piliouline, M., Carretero, J., Bernaola-Galván, P., Carpena, P., Mora-López, L., Sidrach-de-Cardona, M., 2013.** Losses produced by soiling in the incoming radiation to photovoltaic modules. *Progress in photovoltaics: Research and applications* 21, 790–796.